



Connect 400V Mono/ Duo

Einbau- und Betriebsanleitung

DE	Einbau- und Betriebsanleitung.....	2
EN	Installation and operating instructions.....	24
FR	Instructions de pose et d'utilisation.....	46
IT	Istruzioni per l'installazione e l'uso.....	69
NL	Inbouw- en bedieningshandleiding	92
PL	Instrukcja zabudowy i obsługi.....	114



Einbau- und Betriebsanleitung

Inhalt

1	Hinweise zu dieser Anleitung.....	3
2	Sicherheit.....	4
3	Technische Daten.....	9
4	Montage.....	10
5	Betrieb.....	14
6	Produktkonformität_Product compliance_009-590..	140

Liebe Kundin, lieber Kunde,

als Premiumhersteller von innovativen Produkten für die Entwässerungstechnik bietet KESSEL ganzheitliche Systemlösungen und kundenorientierten Service. Dabei stellen wir höchste Qualitätsstandards und setzen konsequent auf Nachhaltigkeit - nicht nur bei der Herstellung unserer Produkte, sondern auch im Hinblick auf deren langfristigen Betrieb setzen wir uns dafür ein, dass Sie und Ihr Eigentum dauerhaft geschützt sind.

Ihre KESSEL SE + Co. KG

Bahnhofstraße 31

85101 Lenting, Deutschland



Bei technischen Fragestellungen helfen Ihnen gerne unsere qualifizierten Servicepartner vor Ort weiter.

Ihren Ansprechpartner finden Sie unter:

www.kessel.de/kundendienst



Bei Bedarf unterstützt unser Werkskundendienst mit Dienstleistungen wie Inbetriebnahme, Wartung oder Generalinspektion in der gesamten DACH-Region, andere Länder auf Anfrage.

Informationen zur Abwicklung und Bestellung finden Sie unter:

www.kessel.de/service/dienstleistungen

1 Hinweise zu dieser Anleitung

Bei diesem Dokument handelt es sich um die Originalbetriebsanleitung. Die Sprache der Originalbetriebsanleitung ist Deutsch. Alle weiteren Sprachen dieser Anleitung sind eine Übersetzung der Originalbetriebsanleitung.

Folgende Darstellungskonventionen erleichtern die Orientierung:

Darstellung	Erläuterung
[1]	siehe Abbildung 1
(5)	Positionsnummer 5 von nebenstehender Abbildung
1 2 3 4 5 ...	Handlungsschritt in Abbildung
👁️ Prüfen, ob Handbetrieb aktiviert wurde.	Handlungsvoraussetzung
▶ OK betätigen.	Handlungsschritt
✓ Anlage ist betriebsbereit.	Handlungsergebnis
siehe "Sicherheit", Seite 4	Querverweis auf Kapitel 2
Fettdruck	besonders wichtige oder sicherheitsrelevante Information
<i>Kursivschreibung</i>	Variante oder Zusatzinformation (z. B. gilt nur für ATEX-Variante)
📘	Technische Hinweise, die besonders beachtet werden müssen.

Folgende Symbole werden verwendet:

Zeichen	Bedeutung
	Gerät freischalten!
	Gebrauchsanweisung beachten
	CE-Kennzeichnung
	Warnung Elektrizität
	WEEE-Symbol, Produkt unterliegt RoHS-Richtlinie
 WARNUNG	Warnt vor einer Gefährdung von Personen. Eine Missachtung dieses Hinweises kann schwerste Verletzungen oder Tod zur Folge haben.
 VORSICHT	Warnt vor einer Gefährdung von Personen und Material. Eine Missachtung dieses Hinweises kann schwere Verletzungen und Materialschäden zur Folge haben.
	Warnt vor explosionsfähiger Atmosphäre.

2 Sicherheit

2.1 Personal - Qualifikation

Für den Betrieb der Anlage gelten die jeweils gültige Betriebssicherheitsverordnung und die Gefahrstoffverordnung oder nationale Entsprechungen.

Der Betreiber der Anlage ist dazu verpflichtet:

- ▶ eine Gefährdungsbeurteilung zu erstellen,
- ▶ entsprechende Gefährdungszonen zu ermitteln und auszuweisen,
- ▶ Sicherheitsunterweisungen durchzuführen,
- ▶ gegen die Benutzung durch Unbefugte zu sichern.

Person ¹⁾	freigegebene Tätigkeiten an KESSEL-Anlagen		
Betreiber	Sichtprüfung, Inspektion		
Sachkundiger (kennt, versteht Betriebsanweisung)		Funktionskontrolle, Konfiguration des Schaltgerätes	
Elektrofachkraft VDE 0105 (nach Vorschriften für elektr. Sicherheit, oder nach nationalen Entsprechungen)			Arbeiten an elektrischer Installation

1) Bedienung und Montage darf nur durch Personen erfolgen, die das 18. Lebensjahr vollendet haben.

2.2 Allgemeine Sicherheitshinweise



ACHTUNG **Anlage freischalten!**



- ▶ Sicherstellen, dass die elektrischen Geräte während der Arbeiten von der Spannungsversorgung getrennt sind.
- ▶ Die elektrischen Geräte gegen Wiedereinschalten sichern.



WARNUNG

Spannungsführende Teile! Das Gehäuse des Schaltgeräts darf nur von einer Elektrofachkraft geöffnet werden!

Die Tätigkeiten am Schaltgerät sind auf:

- ▶ das Einschalten des Schützes und das Anpassen des Motorschutzschalters,
- ▶ den Tausch der Batterien,
- ▶ das Anschließen nach Einbauanleitung und Anschlussplan beschränkt.

Alle darüber hinausgehenden Arbeiten dürfen lediglich durch den KESSEL-Kundendienst oder einen Servicepartner der KESSEL SE + Co. KG durchgeführt werden.



WARNUNG

Spannungsführende Teile

Bei Tätigkeiten an elektrischen Leitungen und Anschlüssen Folgendes beachten.

- ▶ Für alle Anschlüsse und Installations-Arbeiten an der Anlage gelten nationale Vorschriften zur elektrischen Sicherheit.
- ▶ Die Anlage muss über eine Fehlerstrom-Schutzeinrichtung (RCD) mit einem Bemessungsfehlerstrom von nicht mehr als 30mA versorgt werden.



Betriebs- und Wartungsanleitungen müssen am Produkt verfügbar gehalten werden.



ACHTUNG

Unsachgemäße Reinigung

Kunststoff-Bauteile können beschädigt oder brüchig werden

- ▶ Kunststoff-Bauteile ausschließlich mit Wasser und pH-neutralem Reinigungsmittel reinigen.

2.3 Bestimmungsgemäße Verwendung

Das Schaltgerät stellt die Steuerung einer Hebeanlage oder Pumpstation für Abwasser dar. Als Niveauerfassung werden Schwimmerschalter verwendet. Ist das Schalthniveau erreicht, wird das Abpumpen aktiviert. Ist das Niveau entsprechend abgesunken, wird das Abpumpen selbsttätig beendet.

Je nach Variante, ist das Schaltgerät für eine (Mono) oder zwei Pumpen (Duo) bestimmt.



WARNUNG

Das Schaltgerät selbst ist NICHT für den Einbau in einer EX-Zone vorgesehen!

Das Schaltgerät beinhaltet ein zugehöriges elektrisches Betriebsmittel für eigensichere Stromkreise.

Alle nicht vom Hersteller ausdrücklich und schriftlich autorisierten:

- Abweichungen von der technischen Spezifikation
- Um- oder Anbauten
- Verwendungen von nicht originalen Ersatzteilen
- Reparaturen durchgeführt von nicht vom Hersteller autorisierten Betrieben oder Personen

können zum Verlust der Gewährleistung führen.

Hinweise zur Positionierung von Freiluftsäulen





WARNUNG

Überschreitung der maximal zulässigen Betriebstemperatur

Mögliche Störung des Schaltgerätes

- ▶ Den Aufstellort der Freiluftsäule berücksichtigen.
- ▶ Die Sonneneinwirkung am Aufstellort bewerten.
- ▶ Die Umgebungsbedingungen vor Ort berücksichtigen.

Die folgende Tabelle gibt einen Überblick über die erforderlichen Maßnahmen:

	Regelmäßige, starke Sonneneinwirkung von 8 und mehr Stunden und/oder Stau von erwärmter Umgebungsluft zu erwarten	Montage eines Kühlgerätesets für Freiluftsäulen (Art.-Nr. 681148) erforderlich.
	Unregelmäßige, zeitweise erhöhte Sonneneinstrahlung zu erwarten	Montage eines handelsüblichen Lüfters mit Temperaturerkennung zur Belüftung des Innenraumes erforderlich. Belüftung sollte ab einer Innentemperatur des Schaltschranks von 40 °C einsetzen.
	Durchgängig beschatteter Aufstellort und/oder Umgebungsbedingungen mit geringen Temperaturschwankungen	Keine Maßnahmen erforderlich.

2.3.1 Baugruppen- und Funktionsübersicht

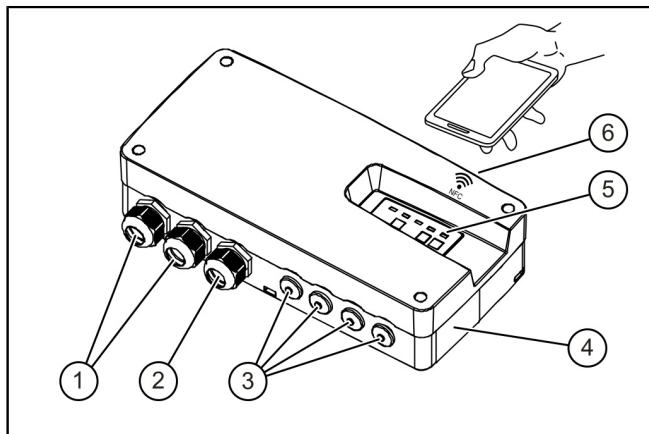

(1)	Anschlüsse für Pumpe(n)
(2)	Netzanschlussleitung
(3)	Blindstopfen, optionale Anschlüsse
(4)	Typenschild
(5)	LEDs und Bedienfeld
(6)	NFC

2.3.2 Anzeigen, Bedientasten und deren Funktionen

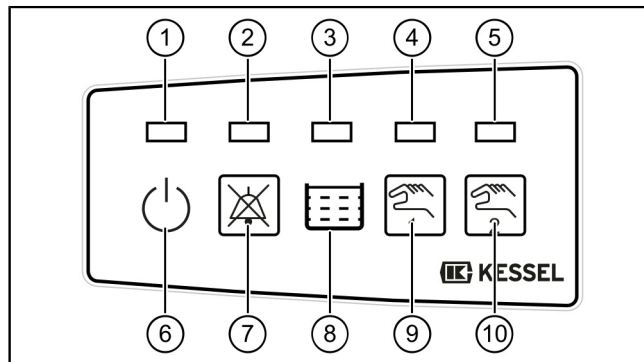

(1)	LED Betriebsbereit (grün)
(2)	LED Alarm (rot)
(3)	LED Einschaltniveau erreicht (orange)
(4)	LED Abwasserpumpe läuft (orange)
(5)	LED Abwasserpumpe läuft (orange), (nur Duo)
(6)	Symbol Betrieb
(7)	Taste Alarm ausschalten (quittieren)
(8)	Symbol Anlagenbehälter
(9)	Taste Abwasserpumpe ein (manuell)
(10)	Taste Abwasserpumpe ein (manuell), (nur Duo)

3 Technische Daten

Angabe	Mono	Duo
Maximale Leistung am Schaltausgang (bei $\cos \varphi = 1$)	4 kW	2 x 4 kW
Nennstrombereich	2,5 - 6 A	2,5 - 6 A*
Gewicht	1 kg	1,3 kg
Abmessungen (LxBxT)	234x184x75 mm	305x184x75 mm
Betriebsspannung	400 V / 50 Hz	
Leistung, Standby	2 W	
Potentialfreier Kontakt	Max. 42 V DC / 0,5 A	
Batteriespezifikation	9 V 6LR61	
Einsatztemperatur	0 - 50 °C	
Relative Luftfeuchtigkeit [%] (nicht kondensierend)	Max. 90 %	
Schutzart	IP 54	
Schutzklasse	I	
Erforderliche Sicherung, A, (Mono)	C16	C16 (C20**)
RCD	30 mA	

* Duo-Anlagen verfügen über zwei Pumpen mit identischen technischen Daten.

** bei Pumpen mit insgesamt mehr als 5 A ausgewiesenem Nennstrombereich

4 Montage

4.1 Schaltgerät montieren

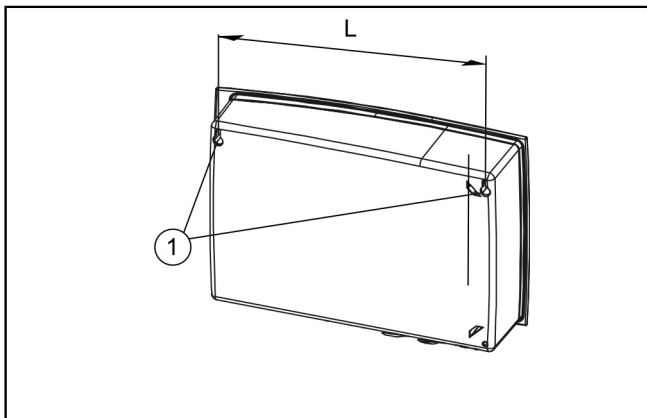

(L)	Mono : mitte-mitte Schlüsselloch 208 mm Duo : mitte-mitte Schlüsselloch 277 mm
-----	---

- ▶ Montageposition wählen, dabei Folgendes sicherstellen:
 - Eine passende Stromversorgung befindet sich in unmittelbarer Nähe zum Schaltgerät.
 - Das Schaltgerät muss zugänglich, sicher und ausreichend befestigt werden.

- ▶ Alle Befestigungsschrauben montieren. Dabei sicherstellen, dass der Abstand zwischen den Schraubenköpfen und der Befestigungsfläche ca. 3 bis 4 mm beträgt.
- ▶ Schaltgerät an den Befestigungsschrauben einhängen und leicht nach unten drücken.
- ⓘ Das Schaltgerät ist ausschließlich für die Innenmontage oder Montage in einer KESSEL Freiluftsäule bestimmt. Es darf keiner direkten Sonneneinstrahlung ausgesetzt werden und muss in einer trockenen, gut belüfteten und frostfreien Umgebung installiert werden.

4.2 Anschlussplan

Je nach Produkt, ist der jeweilige Anschlussplan zu verwenden.

Anschlussplan Mono 400V: Aquapump Small Mono und Aqualift L Mono	<i>siehe "Anschlussplan Mono ", Seite 137</i>
Anschlussplan Duo 400V: Aquapump Small Duo	<i>siehe "Anschlussplan Duo", Seite 138</i>
Anschlussplan Duo 400V: Aqualift L Duo	<i>siehe "Anschlussplan Duo Aqualift L", Seite 139</i>

4.3 Elektrischer Anschluss



GEFAHR

Gefahr durch falsch dimensionierte Anschlussleitungen.

Die Anlage ist ausschließlich für den Betrieb mit den mitgelieferten Anschlussleitungen (oder gleichwertig) vorgesehen. Im Zweifelsfall mit Hersteller / Lieferant Rücksprache halten.

KESSEL

- Die Anschlusskabel sicher vom Anlagenbehälter zum Schaltgerät verlegen (z.B. Kabelleerrohr). Ausreichend Kabellänge für die Wartung der elektrischen Komponenten vorhalten.
- ▶ Adernendhülsen (Länge 8 mm) an den Kabelenden anbringen.
- ▶ Gehäusedeckel abschrauben und entfernen.

Mono/Duo: 4 Schrauben in jeder Ecke des Gehäusedeckels

- ▶ Anschlusskabel durch entsprechende Kabeldurchführung führen ggf. Sollbruchstellen an den benötigten vorgegebenen Kabeldurchführungen öffnen. ❶



ACHTUNG
IP54 beachten

- ▶ Kabeldurchführungen mit geeignetem Werkzeug herausbrechen. ❷
- ▶ Gummi-Kabeldurchführungen in die Öffnungen eindrücken. ❸
- ▶ Nippel der eingesetzten Kabeldurchführungen abschneiden. ❹
- ▶ Anschlusskabel gemäß Anschlussplan an den Klemmleisten befestigen.
Dazu mit einem geeigneten Schraubendreher die jeweilige Kabelklemme gegen den Federdruck hinuntergedrückt halten, bis das Kabelende hineingesteckt ist. ❺

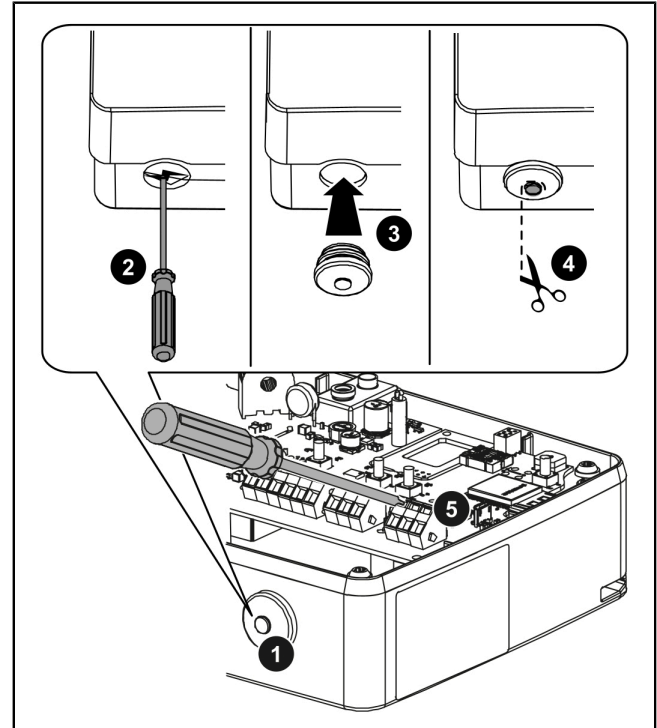

- ▶ Die Anschlusskabel sicher vom Anlagenbehälter zum Schaltgerät verlegen (z.B. Kabelleerrohr). Ausreichend Kabellänge für die Wartung der elektrischen Komponenten vorhalten.
- ▶ Batteriestecker an der Batterie anstecken. **6**
- ▶ Kabel der Batterie so verlegen, dass die LEDs nicht verdeckt oder eingeklemmt werden.
- ▶ Zugentlastungen für alle Anschlusskabel befestigen, Anzugsdrehmoment 0,5 Nm. **7**
- ▶ Gehäusedeckel aufsetzen und befestigen, Anzugsdrehmoment der Schrauben 1,2 Nm.

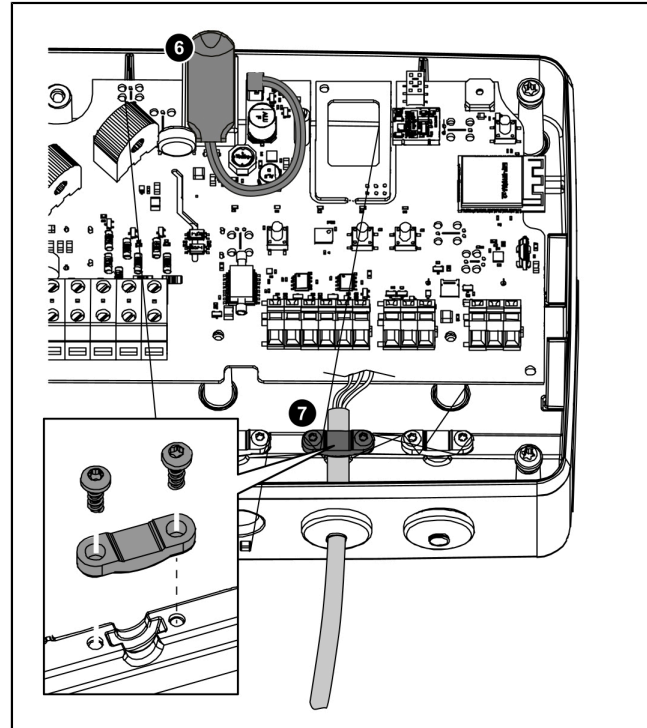

5 Betrieb

5.1 Automatikbetrieb

Die Anlage befindet sich im Automatikbetrieb, wenn kein Fehler erkannt wurde und die Betriebs-LED (1) grün leuchtet.

Die Abwasserpumpe wird entsprechend dem Abwasserpegel ein- und ausgeschaltet.

Bei Schaltgeräten 400V Mono/Duo ist möglich mit der KESSEL NFC App und einem NFC fähigen Endgerät (z.B. Mobiltelefon) das Logbuch des Schaltgerätes auszulesen, Datum und Uhrzeit zu synchronisieren und diverse Parameter anzupassen.

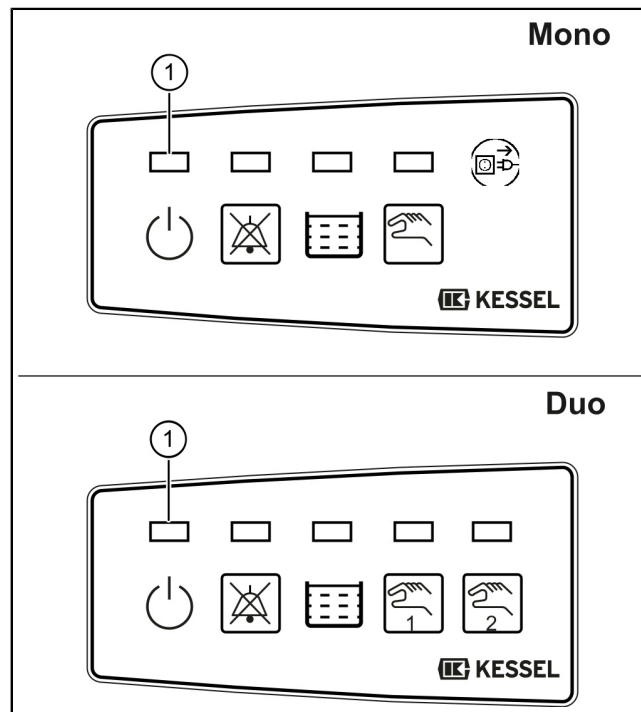

5.2 Alarmzustände

Alarm Anlagenbehälter zu voll

- Überschreitet der Pegelstand im Anlagenbehälter das Alarmniveau (Schwimmerschalter), wird Alarm ausgelöst, die Alarm-LED (2) blinkt und ein Signalton wird erzeugt. Die Abwasserpumpe läuft.
- Dieser Alarmzustand lässt sich nicht quittieren, er wird nur durch ein erfolgreiches Abpumpen ausgeschaltet. Der akustische Ton kann ausgeschaltet werden (kurz auf die Alarm-Taste drücken).

Alarm Stromversorgung ausgefallen

- Fällt die Spannungsversorgung aus, erlischt nach einer Sekunde die grüne Betriebs-LED (1), die Alarm-LED (2) blinkt und ein wiederkehrender Signalton wird erzeugt. Die Abwasserpumpe kann nicht mehr eingeschaltet werden.
- Kehrt die Spannungsversorgung zurück, zeigt das Schaltgerät diesen Alarmzustand nicht mehr an, die Anlage funktioniert wieder wie im Automatikbetrieb.

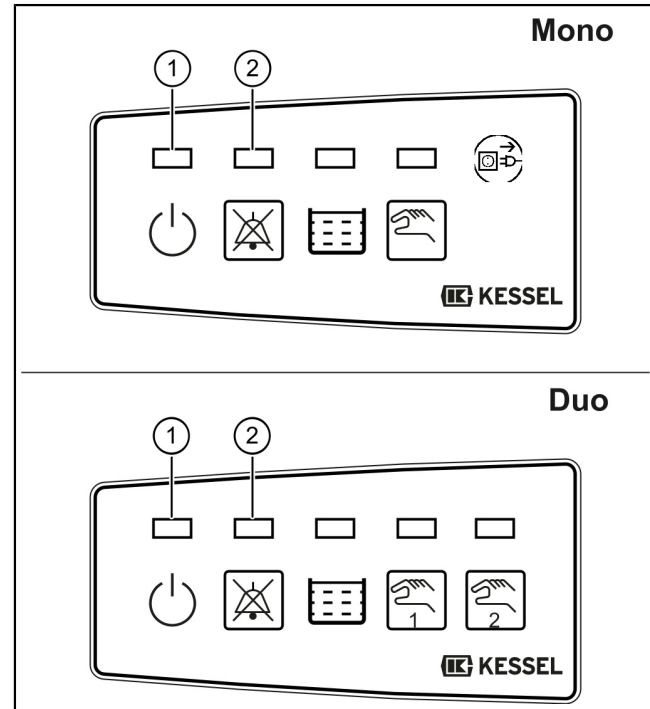

5.3 Handbetrieb

Der Handbetrieb kann mit der Taste (9) / (10) aktiviert werden. Es findet dann kein automatisches Einschalten der Abwasserpumpe mehr statt.

Wird der Handbetrieb während des Abpumpens eingeschaltet, schaltet das die Abwasserpumpe aus.

Handbetrieb aktivieren

- ▶ Taste (9) / (10) betätigen, die Handbetrieb-LED (4) / (5) blinkt orange.

Bei aktiviertem Handbetrieb kann die Abwasserpumpe wie folgt eingeschaltet werden:

Kurzzeitig einschalten

- ▶ Taste (9) / (10) 1x drücken.
- ✓ Die Abwasserpumpe wird für einen kurzen Zeitraum eingeschaltet.

Länger einschalten

- ▶ Taste (9) / (10) drücken und so lange gedrückt halten, wie die Abwasserpumpe eingeschaltet sein soll.
- ✓ Die Abwasserpumpe wird eingeschaltet.

① Wird der Handbetrieb > 5 min nicht benutzt, aktiviert das Schaltgerät den Automatikbetrieb.

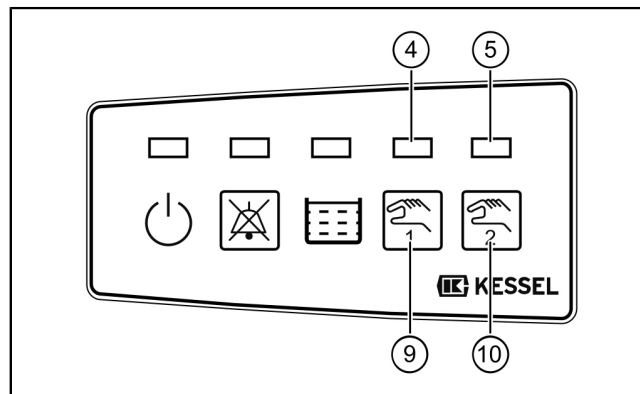

5.4 Übersicht LED-Anzeigen - Informationen

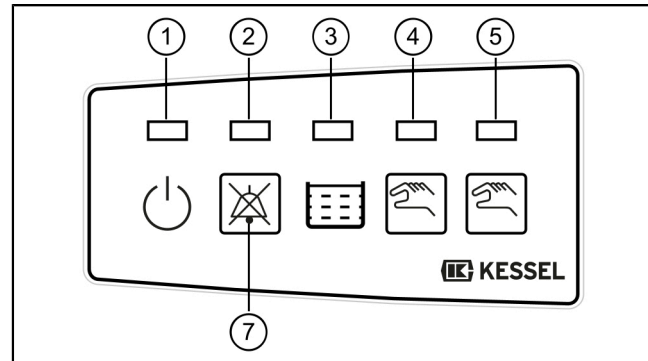

Blinkmuster LED 1 - 5*

- Blinken
- Leuchten / Eingeschaltet
- Ausgeschaltet
- Blinken im Wechsel
- Blinken gleichzeitig
- 5* Nur bei Aqualift L DUO



Betriebszustände

LED				Signalton (Intervall)	PFK ¹	Beschreibung	Maßnahme
grün (1)	rot (2)	orange (3)	orange (4) / (5*)				
				-	-	Außer Betrieb, keine Batterieüberwachung ²	Netzspannung wiederherstellen





















LED				Signalton (Intervall)	PFK ¹	Beschreibung	Maßnahme
 grün (1)	 rot (2)	 orange (3)	 orange (4) / (5*)				
●	○	○	○	-	-	Betriebsbereit	-
●	○	●	◐	-	-	Anlagenbehälter voll, es wird in Kürze abgepumpt	Keine Maßnahme notwendig, Abwasserpumpe kann mit Taste (8) ausgeschaltet werden (<i>siehe "Handbetrieb", Seite 16</i>)
●	○	●	●	-	-	Anlagenbehälter wird leergepumpt	





¹ Potentialfreier Kontakt wird aktiviert (Art.-Nr. 80074 muss zuvor aktiviert und angeschlossen worden sein).

² Die Batterieüberwachung ist nur aktiv, wenn bei Inbetriebnahme eine Batterie angeschlossen war.

5* Nur bei Aqualift L DUO

Alarmzustände / Fehler

LED				Signalton (Intervall)	PFK ¹	Beschreibung	Maßnahme
grün (1)	rot (2)	orange (3)	orange (4)/ (5*)				
				✓	Ja	Batteriefehler ²	Batterie austauschen
				✓	Ja	Netzausfall, Netzspannung fehlt, Anlage ohne Funktion	Netzspannung wieder herstellen, Alarm quittieren
				✓	Ja	Niveaufehler, unlogische Reihenfolge der Niveaus wurde erkannt	Alarm quittieren. Zulauf kontrollieren, Rückflussverhinderer überprüfen, Niveau Fehler - Schwimmerschalter überprüfen.
				✓	Ja	Grenzlaufzahl /-zeit, Abwaspumpe wurde zu oft/ zu lange eingeschaltet	
				✓	Ja	Alarmniveau überschritten	Warten, bis Alarmniveau wieder unterschritten

LED				Signalton (Intervall)	PFK ¹	Beschreibung	Maßnahme
 grün (1)	 rot (2)	 orange (3)	 orange (4)/ (5*)				
				-	-	Maximale Schalt- spiele überschritten	Alarm quittieren und Schaltgerät tauschen

¹ Potentialfreier Kontakt wird aktiviert.

² Die Batterieüberwachung ist nur aktiv, wenn bei Inbetriebnahme eine Batterie angeschlossen war.

5* Nur bei Aqualift L DUO

Alarm quittieren

Tritt ein Zustand auf, der einen Alarm auslöst, wird das durch das Leuchten der Alarm-LED (2) und ggf. einer der anderen LEDs angezeigt. Nach der Beseitigung der Ursache für den Alarm, kann der Alarm durch Drücken der Taste (7) quittiert werden.

Alarmton ausschalten

- ▶ Taste (7) 1x drücken

Alarm quittieren

- ▶ Taste (7) > 3 Sekunden gedrückt halten.

✓ Die Alarm-Anzeige erlischt, der Alarm ist quittiert.



5.5 Daten auslesen und Parameter einstellen

Mit der KESSEL NFC App und einem NFC fähigen Endgerät (z.B. Mobiltelefon) ist es möglich das Logbuch des Schaltgerätes auszulesen, Datum und Uhrzeit zu synchronisieren und diverse Parameter anzupassen.



WARNUNG

Vor Benutzung der App ist das Schaltgerät in Betrieb zu nehmen *siehe "Kapitel Betrieb", Seite 14.*

Apple Store	Google Play Store
	
<p>https://apps.apple.com/de/app/kessel-nfc/id6449256249</p>	<p>https://play.google.com/store/apps/details?id=com.kessel.nfcapp&gl=DE</p>



Abb.: Endgerät - Smartphone

Schaltgerät lesen

Dazu muss sich das NFC fähig Endgerät direkt am Schaltgerät befinden ("*Abb. Endgerät-Smarthphone*").

Parameter anzeigen und bearbeiten:

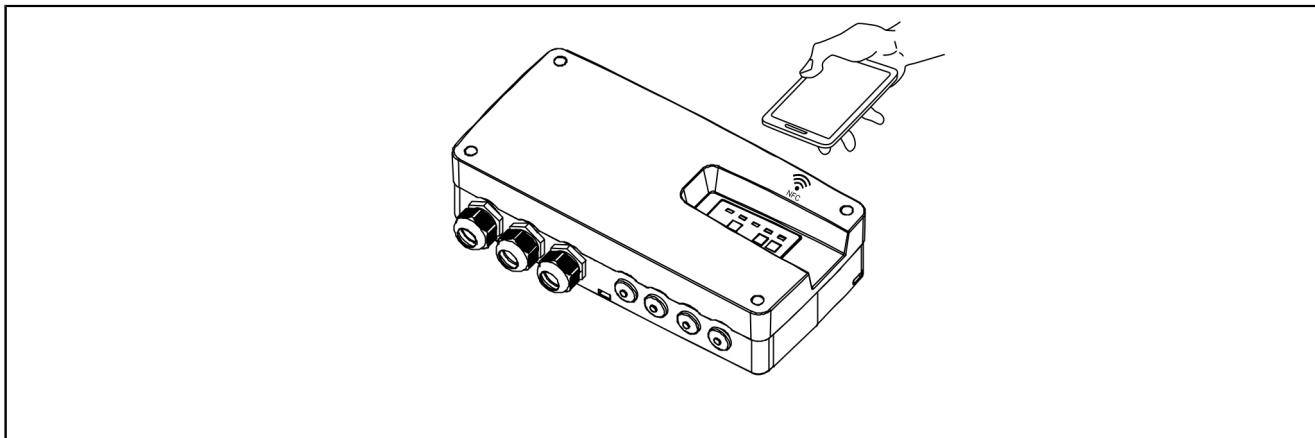
Diese können kopiert und per Email versendet werden.

(Passwort 1000)

5.6 Datum/Uhrzeit synchronisieren

Werte von NFC fähigem Gerät auf das Schaltgerät übertragen.

5.7 Anlage ausschalten

- ▶ Anlage freischalten.
 - ▶ Taster Alarm (7) drücken und so lange gedrückt halten, bis die Alarm-LED (2) nicht mehr blinkt, dann fährt das Schaltgerät selbsttätig herunter.
- ① Ist das Schaltgerät ausgeschaltet, ist der Batterieanschluss deaktiviert. Die Batterie kann angesteckt bleiben, da keine Entladung stattfindet. Zur Initialisierung wird Netzspannung benötigt, da damit der Batterieanschluss wieder aktiviert wird.

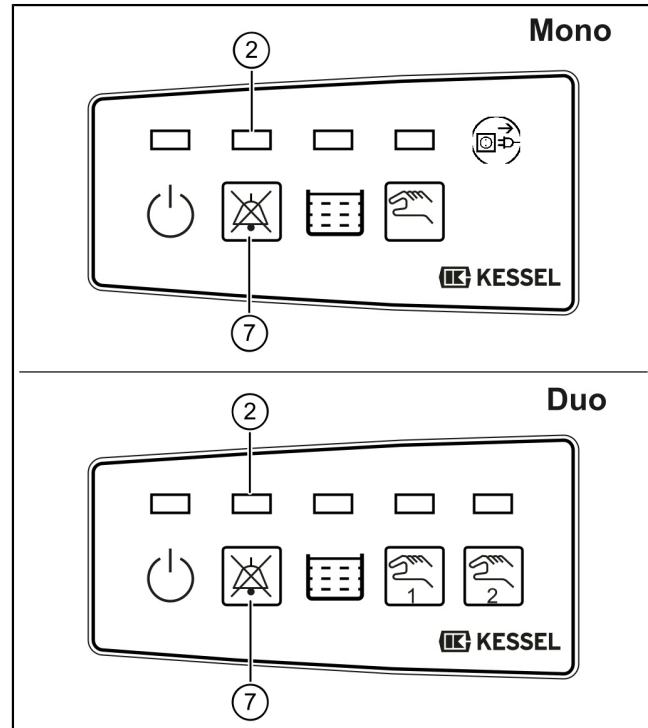

Installation and operating instructions

Contents

1	Notes on this manual.....	25
2	Safety.....	26
3	Technical data.....	31
4	Installation.....	32
5	Operation.....	36

Dear Customer,

As a premium manufacturer of innovative products for draining technology, KESSEL offers integrated system solutions and customer-oriented service. In doing so, we set the highest quality standards and focus firmly on sustainability - not only with the manufacturing of our products, but also with regard to their long-term operation and we strive to ensure that you and your property are protected over the long term.

Your KESSEL SE + Co. KG
Bahnhofstraße 31
85101 Lenting, Germany



Our local, qualified service partners would be happy to help you with any technical questions. You can find your contact partner at:

www.kessel.de/kundendienst





If necessary, our Factory Customer Service provides support with services such as commissioning, maintenance or general inspection throughout the DACH region, other countries on request.

For information about handling and ordering, see: www.kessel.de/service/dienstleistungen

1 Notes on this manual

This document is a translation of the original operating instructions. The original operating instructions are written in German. All other language versions of these instructions are a translation of the original operating instructions.

The following conventions make it easier to navigate the manual:

Symbol	Explanation
[1]	See Figure 1
(5)	Position number 5 from the adjacent figure
1 2 3 4 5 ...	Action step in figure
 Check whether manual operation has been activated.	Prerequisite for action
 Press OK.	Action step
✓ System is ready for operation.	Result of action
see "Sicherheit", page 26	Cross-reference to Chapter 2
Bold type	Particularly important or safety-relevant information
<i>Italics</i>	Variants or additional information (e.g. applicable only for ATEX variants)
	Technical information or instructions which must be paid particular attention.

The following symbols are used:

Icon	Meaning
	Isolate device!
	Observe the instructions for use
	CE marking
	Warning, electricity
	WEEE icon, product is subject to the RoHS Directive
 WARNING	Warns of a hazard for persons. Disregarding this warning can lead to very serious injuries or death.
 CAUTION	Warns of a hazard for persons and material. Disregarding this warning can lead to serious injuries and material damage.
	Warns of potentially explosive atmospheres.

2 Safety

2.1 Personnel - qualification

The relevant operational safety regulations and the hazardous substances ordinance or national equivalents apply for the operation of the system.

The operator of the system must:

- ▶ prepare a risk assessment
- ▶ identify and demarcate corresponding hazard zones
- ▶ carry out safety training
- ▶ secure the system against unauthorised use.

Person ¹⁾	Approved activities on KESSEL systems		
Operating company	Visual inspection, inspection		
Technical expert, (familiar with, understands operating instructions)		Functional check, configuration of the control unit	
Electrical specialist VDE 0105 (per regulations for electrical safety, or per national equivalents)			Work on electrical installation

1) Operation and assembly work may only be carried out by persons who are 18 years of age.

2.2 General safety notes



NOTICE

Disconnect system from energy sources!

- ▶ Ensure that the electrical equipment is disconnected from the power supply during the work.
- ▶ Secure the electrical equipment against being switched on again.



WARNING

Live parts! The housing of the control unit may only be opened by a qualified electrician!

Work on the control unit is restricted to:

- ▶ Switching on the contactor and adjusting the motor protection switch,
- ▶ replacing the batteries,
- ▶ Connection in accordance with the installation instructions and wiring diagram.

All work extending beyond this may only be carried out by KESSEL customer service or a KESSEL SE + Co. KG service partner.



WARNING

Live parts

Heed the following points when working on electrical cables and connections.

- ▶ The national regulations concerning electrical safety apply to all connections and installation work.
- ▶ The system must be supplied through a residual current protection device (RCD) with residual current of not more than 30mA.



Operating and maintenance instructions must be kept available at the product.



NOTICE

Improper cleaning

- Plastic components can become damaged or brittle
- ▶ Only clean plastic components with water and a pH-neutral cleaning agent.

2.3 Intended use

The control unit represents the control of a lifting station or a pumping station for wastewater. Float switches are used as level sensors. If the switching level has been reached, pumping off is activated. If the level has fallen accordingly, pumping off is ended automatically.

Depending on the version, the control unit is intended for one (Mono) or two (Duo) pumps.



WARNING

The control unit itself is NOT intended for installation in an EX zone!

The control unit includes corresponding electrical equipment for intrinsically safe electric circuits.

All:

- Deviations from the technical specification
- Modifications or attachments
- Use of non-genuine spare parts
- Repairs carried out by companies or persons not authorised by the manufacturer

without the express and written approval of the manufacturer can lead to a loss of warranty.

Notes on positioning outdoor cabinets





WARNING

Exceeding the maximum permissible operating temperature

Possible malfunction of the control unit

- ▶ Take the installation location of the outdoor cabinet into account.
- ▶ Evaluate the sunshine at the installation site.
- ▶ Take the ambient conditions on site into account.

The following table gives an overview of the required measures.

	<p>Regular strong sunshine for 8 or more hours and/or accumulation of heated ambient air to be expected</p>	<p>Installation of a cooling unit set is required for outdoor cabinets (art. no. 681148).</p>
	<p>Irregular, at times increased sunshine to be expected</p>	<p>The following table gives an overview of the required measures. Ventilation should start up from an internal control cabinet temperature of 40 °C.</p>
	<p>Continuously shaded installation site and/or ambient conditions with small temperature fluctuations</p>	<p>No measures required.</p>

2.3.1 Assemblies and functional overview

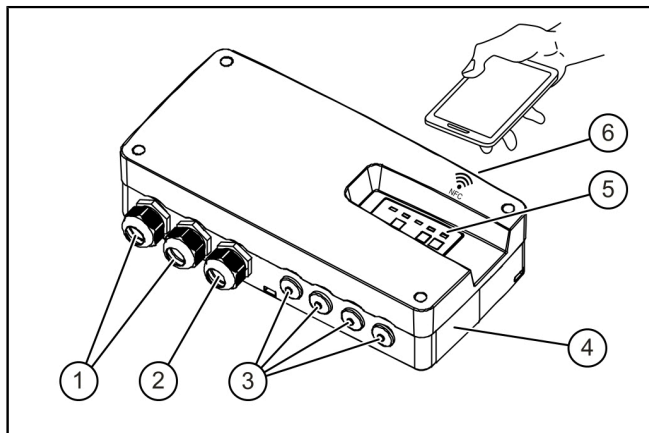

(1)	Connections for pump(s)
(2)	Mains cable
(3)	Blind plug, optional connections
(4)	Type plate
(5)	LEDs and control panel
(6)	NFC

2.3.2 Displays, operating keys and their functions

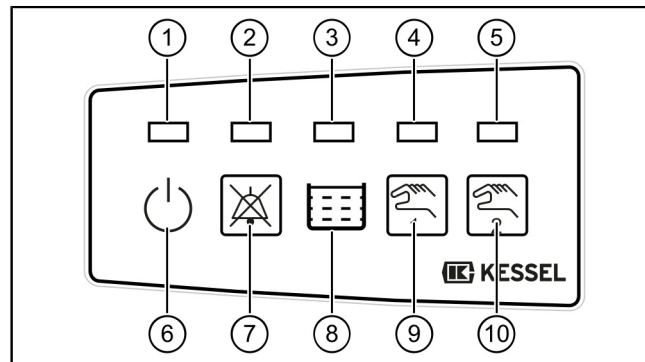

(1)	Ready for operation LED (green)
(2)	Alarm LED (red)
(3)	LED switch-on level reached (orange)
(4)	LED wastewater pump running (orange)
(5)	LED wastewater pump running (orange), (Duo only)
(6)	Operation symbol
(7)	Switch off (acknowledge) alarm button
(8)	System tank symbol
(9)	Wastewater pump on (manual) button
(10)	Wastewater pump on (manual) button, (Duo only)

3 Technical data

Information	Mono	Duo
Maximum power at the switch output (if $\cos \varphi = 1$)	4 kW	2 x 4 kW
Nominal current range	2.5 - 6 A	2.5 - 6 A*
Weight	1 kg	1.3 kg
Dimensions (LxWxD)	234x184x75 mm	305x184x75 mm
Operating voltage	400 V / 50 Hz	
Standby power	2 W	
Potential-free contact	max. 42 V DC / 0.5 A	
Battery specification	9 V 6LR61	
Working temperature	0 - 50 °C	
Relative humidity [%] (non-condensing)	Max. 90 %	
Protection rating	IP 54	
Protection class	I	
Required fuse, A, (Mono)	C16	C16 (C20**)
RCD	30 mA	

* Duo systems have two pumps with identical technical data.

** for pumps with more than 5 A designated nominal current range in total



4 Installation

4.1 Installing the control unit

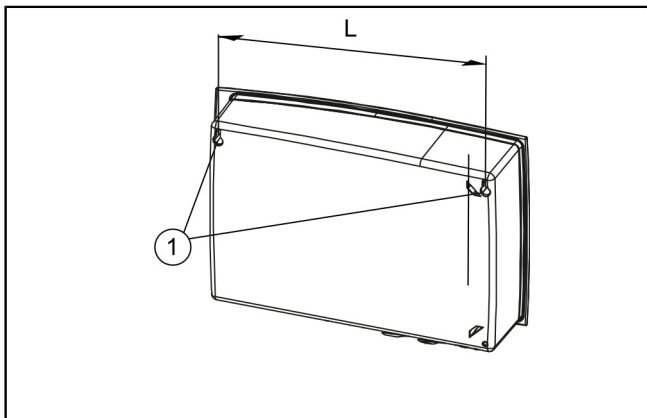

(L)	Mono: centre-centre key hole 208 mm Duo: centre-centre key hole 277 mm
-----	---

- ▶ Select installation position taking the following into account:
 - There is a suitable power supply in the direct vicinity of the control unit.
 - The control unit must be fastened safely and adequately and so that it is accessible.
- ▶ Fit all fastening screws. In doing so, ensure that the distance between the screw heads and the fastening surface is approx. 3 to 4 mm.
- ▶ Hang the control unit on the fastening screws and press downwards gently.
- ⓘ The control unit is solely intended for indoor installation or installation in a KESSEL outdoor cabinet.
It must not be exposed to direct sunshine and must be installed in a dry, well-ventilated and frost-free environment.

4.2 Wiring diagram

Depending on the product, the respective wiring diagram must be used.

Mono 400 V wiring diagram: Aquapump Small Mono and Aqualift L Mono	see "Mono wiring diagram", page 137
Duo 400 V wiring diagram: Aquapump Small Duo	see "Duo wiring diagram", page 138
Duo 400 V wiring diagram: Aqualift L Duo	see "Duo Aqualift L wiring diagram", page 139

4.3 Electrical connection



DANGER

Danger through incorrectly dimensioned connection cables.

The system is intended exclusively for operation with the connection pipes provided (or equivalent). In case of doubt, contact the manufacturer/supplier.

- Lay the connection cable securely (e.g. conduit pipe) from the system tank to the control unit. Ensure that there is adequate cable length for the maintenance of the electrical components.

▶ Attach ferrules (length 8 mm) to the cable ends.

▶ Unscrew and remove the housing cover.

Mono/Duo: 4 screws in each corner of the housing cover

- ▶ Route the connection cable through the appropriate cable gland. If necessary, open predetermined breaking points at the required predefined cable glands. ❶



NOTICE

Observe IP54

- ▶ Break out the cable glands with a suitable tool. ❷
- ▶ Press the rubber cable glands into the openings. ❸
- ▶ Cut the nipples off the inserted cable glands. ❹
- ▶ Fasten the connection cable to the terminal strips in accordance with the wiring diagram.

To do so, use a suitable screwdriver to hold down the respective cable clamp against the spring pressure until the cable end has been inserted. ❺

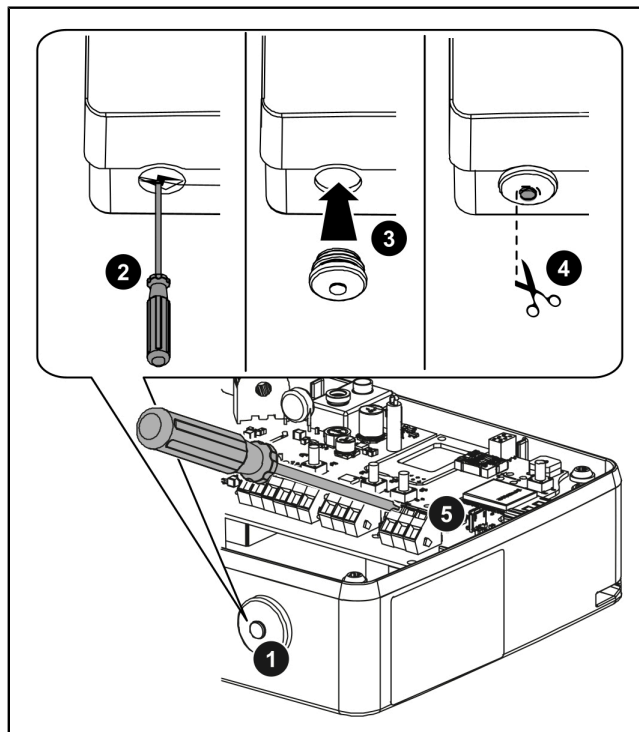

- ▶ Lay the connection cable securely (e.g. conduit pipe) from the system tank to the control unit. Ensure that there is adequate cable length for the maintenance of the electrical components.
- ▶ Fit the battery connector onto the battery. **6**
- ▶ Route the battery cable such that the LEDs are not covered or trapped.
- ▶ Fasten the strain relief for all connection cables, tightening torque 0.5 Nm. **7**
- ▶ Fit the housing cover and fasten in place - screw tightening torque 1.2 Nm.

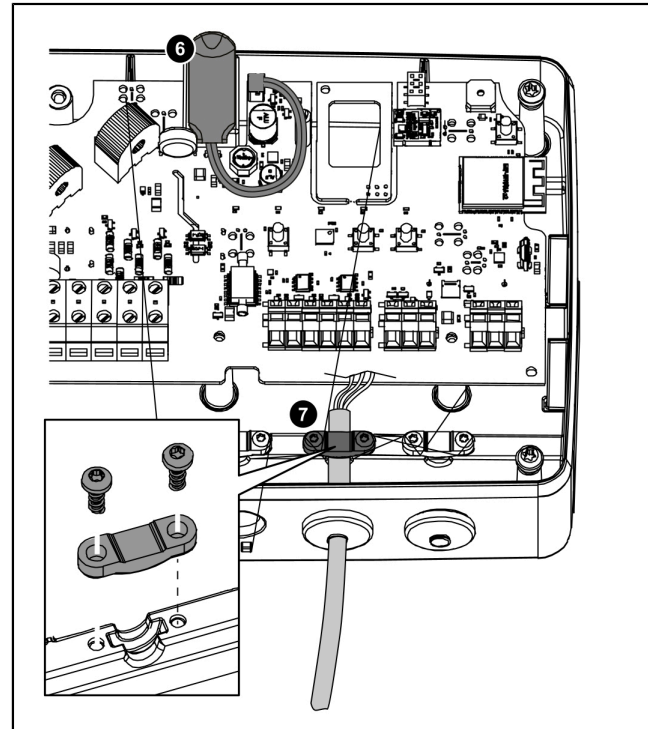

5 Operation

5.1 Automatic operation

The system is in automatic operation, if there are no errors detected and the operating LED (1) is illuminated in green. The wastewater pump is switched on and off in accordance with the wastewater level.

For 400 V Mono/Duo control units it is possible to read out the log book of the control unit with the KESSEL NFC app and an NFC-capable end device (e.g. mobile phone), to synchronise the date and time and to adjust various parameters.

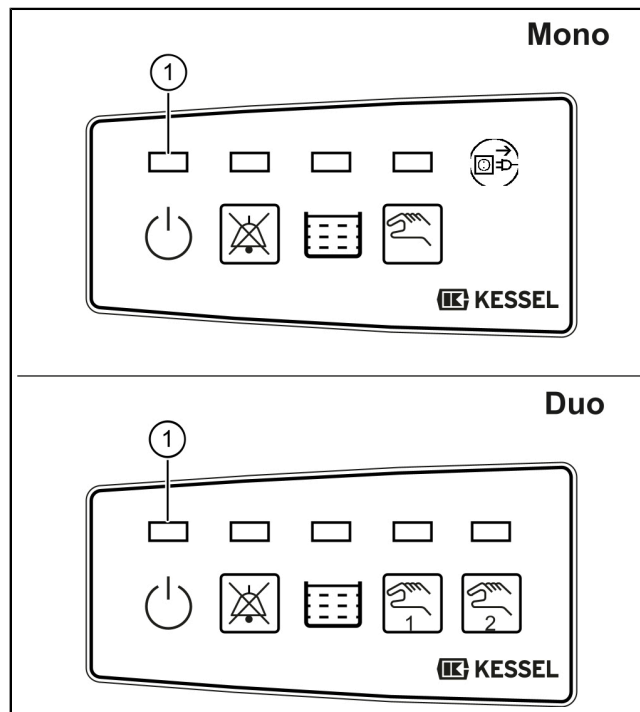

5.2 Alarm statuses

System tank too full alarm

- If the level in the system tank exceeds the alarm level (float switch), the alarm is triggered, the alarm LED (2) flashes and a signal tone is generated. The wastewater pump is running.
- This alarm status cannot be acknowledged, it is only switched off after successful pumping off. The acoustic tone can be switched off (press the alarm button briefly).

Power supply failure alarm

- If the power supply fails, the green operating LED (1) goes out after a second, the alarm LED (2) flashes and a repetitive signal tone is generated. The wastewater pump can no longer be switched on.
- If the power supply returns, the control unit no longer indicates this alarm condition and the system runs in automatic operation once again.

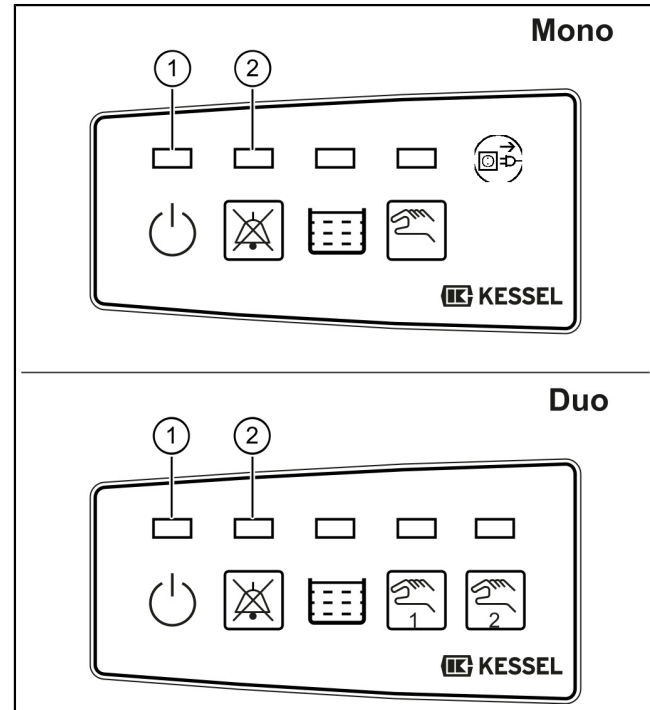

5.3 Manual operation

Manual operation can be activated with button (9) / (10). The wastewater pump is no longer switched on automatically.

If manual operation is switched on during the pumping process, the wastewater pump switches off.

Activate manual operation

- ▶ Press the button (9) / (10), the manual operation LED (4) / (5) flashes orange.

The wastewater pump can be switched on as follows when manual operation is activated:

Switching on briefly

- ▶ Press button (9) / (10) 1x.
- ✓ The wastewater pump will be switched on for a short period.

Switching on for longer



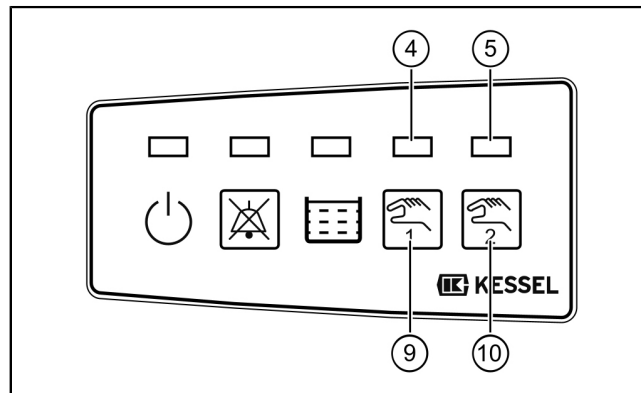

- ▶ Press and keep the button (9) / (10) pressed for as long as the wastewater pump is to be switched on.
- ✓ The wastewater pump is switched on.

ⓘ If manual operation is not used for > 5 min, the control unit activates automatic operation.



5.4 Overview of LED displays - Information





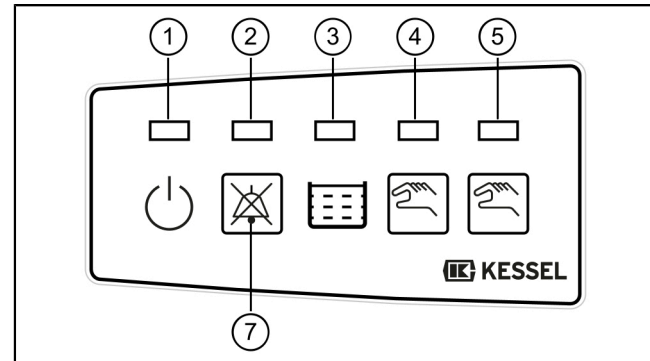



Flashing pattern LED 1 - 5*





-  Flashing
-  Lights up / switched on
-  Switched off
-  Flashing alternately
-  Flashing simultaneously
- 5* Only for Aqualift L DUO



ZEN

Operating states

LED				Acoustic signal (interval)	PFC ¹	Description	Measure
 green (1)	 red (2)	 orange (3)	 orange (4) / (5*)				
				-	-	Out of service, no battery monitoring ²	Restore the mains voltage

























LED				Acoustic signal (interval)	PFC ¹	Description	Measure
 green (1)	 red (2)	 orange (3)	 orange (4) / (5*)				
●	○	○	○	-	-	Ready for operation	-
●	○	●	◐	-	-	System tank full, will be pumped out shortly	No action required, wastewater pump can be switched off with button (8) (see "Manual operation", page 38)
●	○	●	●	-	-	Pumping system tank to empty	

¹ Potential-free contact is activated (art. no. 80074 must have been activated and connected beforehand).

² The battery monitoring is only active if a battery was connected at the time of commissioning.

5* Only for Aqualift L DUO

Alarm statuses / errors

LED				Acoustic signal (interval)	PFC ¹	Description	Measure
green (1)	red (2)	orange (3)	orange (4)/ (5*)				
				✓	Yes	Battery error ²	Replace battery
				✓	Yes	Power outage, mains voltage failed, system non-functional	Reinstate mains voltage, acknowledge alarm
				✓	Yes	Level error, illogical sequence of levels detected	Acknowledge the alarm, check the inlet, check the backflow preventer, level error - check the float switch.
				✓	Yes	Max. number of runs/run-time; wastewater pump was switched on too often/too long	
				✓	Yes	Alarm level exceeded	Wait until the level drops below the alarm level again
				-	-	Maximum switching cycles exceeded	Acknowledge alarm and replace control unit

¹ Potential-free contact is activated.

² The battery monitoring is only active if a battery was connected at the time of commissioning.

5* Only for Aqualift L DUO



Acknowledge alarm

If a condition arises that triggers an alarm, this will be indicated through the illumination of the alarm LED (2) and, if applicable, one of the other LEDs. After rectifying the cause of the alarm, the alarm can be acknowledged by pressing the button (7).

Switching off the alarm tone

- ▶ Press button (7) 1x

Acknowledge alarm

- ▶ Press and hold button (7) > 3 seconds.
- ✓ The alarm indicator goes out, the alarm is acknowledged.

5.5 Data read-out and parameter setting

It is possible to read out the log book of the control unit with the KESSEL NFC app and an NFC-capable end device (e.g. mobile phone), to synchronise the date and time and to adjust various parameters.



WARNING

Before using the app, the control unit must be started up, see see *„Operation“ chapter*, page 36.

Apple Store



<https://apps.apple.com/de/app/kessel-nfc/id6449256249>

Google Play Store



<https://play.google.com/store/apps/details?id=com.kessel.nf-capp&gl=DE>

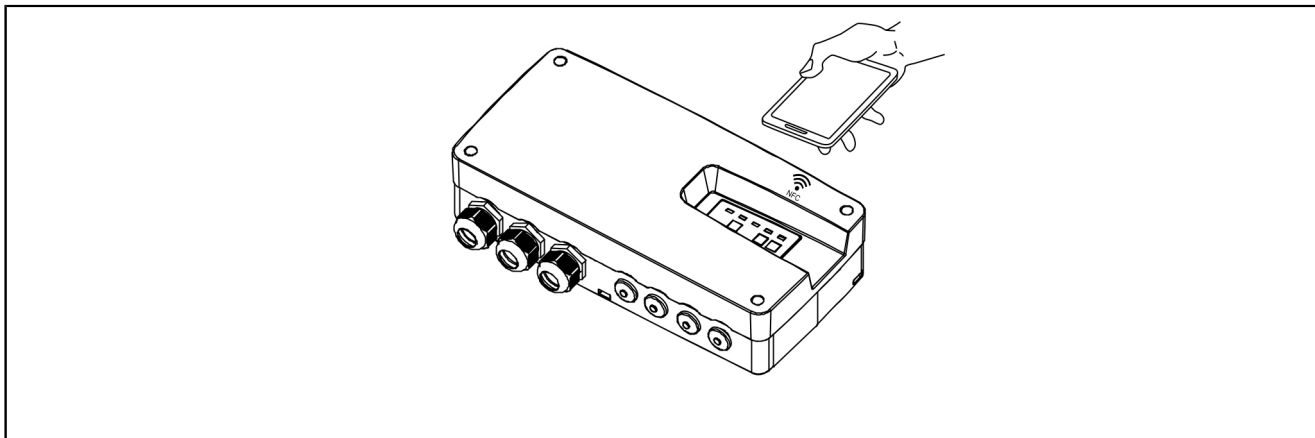

Fig.: End device - smartphone

Read the control unit

To do this, the NFC-capable end device must be located directly on the control unit ("*Fig. End device - smartphone*").

Display and edit parameters:

These can be copied and sent by email. (Password 1000)

5.6 Synchronise the date/time

Transfer values from the NFC-capable device to the control unit.

5.7 Switching off the system

- ▶ Disconnect the system from the power supply.
 - ▶ Press the alarm button (7) and keep it pressed until the alarm LED (2) no longer flashes, the control unit then shuts down automatically.
- ① If the control unit is switched off, the battery connection is deactivated. The battery can remain connected since it will not be discharged. Mains voltage is required for initialisation since this re-activates the battery connection.

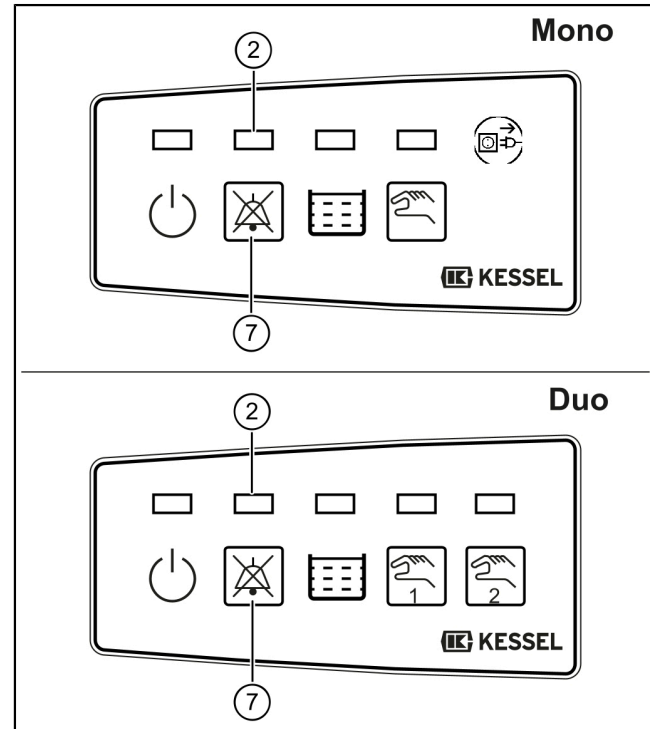

Instructions de pose et d'utilisation

Sommaire

1	Informations spécifiques aux présentes instructions.....	47
2	Sécurité.....	48
3	Caractéristiques techniques.....	54
4	Montage.....	55
5	Fonctionnement.....	59

Chère cliente, cher client,

En qualité de producteur de pointe de produits novateurs dans le domaine de la technique d'assainissement, KESSEL propose des réponses systématiques globales et un service orienté aux besoins de la clientèle. Nous misons simultanément sur les normes de qualité les plus élevées et une durabilité conséquente – non seulement lors de la fabrication de nos produits, mais également pour leur utilisation à long terme afin que vous, et vos biens, soient protégés durablement.

Votre KESSEL SE + Co. KG
Bahnhofstrasse 31
85101 Lenting, Allemagne



Nos partenaires qualifiés du service après-vente se feront un plaisir de répondre à vos questions techniques sur site.

Vous trouverez votre correspondant sur :
www.kessel.de/kundendienst





Si nécessaire, notre propre SAV vous prête son assistance en matière de mise en service, de maintenance ou d'inspection générale en Allemagne, en Autriche et en Suisse, comme dans d'autres pays sur demande.

Toutes les informations de traitement et de commande sont à votre disposition sur :
www.kessel.de/service/dienstleistungen

1 Informations spécifiques aux présentes instructions







Ce document est la traduction de l'original du mode d'emploi. L'original a été rédigé en allemand. Toutes les autres versions linguistiques de ce mode d'emploi sont des traductions de l'original.



Les conventions de représentation suivantes facilitent l'orientation :

Représentation	Explication
[1]	voir figure 1
(5)	Numéro de repère 5 de la figure ci-contre
① ② ③ ④ ⑤ ...	Action de la figure
 Vérifier si le mode manuel a été activé.	Condition de réalisation de l'action
 Valider <OK>.	Action
 Le système est prêt au service.	Résultat de l'action
cf. "Sécurité", page 48	Renvoi au chapitre 2
Caractères gras	particulièrement important ou information importante pour la sécurité
<i>Caractères italiques</i>	Variante ou informations complémentaires (par exemple, uniquement valable pour la variante ATEX)

Représentation	Explication
	informations techniques à observer en particulier.

Les instructions emploient les pictogrammes suivants :

Pictogramme / label	Signification
	Activer l'appareil !
	Observer le mode d'emploi
	Label de conformité CE
	Mise en garde contre l'électricité
	Pictogramme DEEE, produit soumis à la directive RoHS
 MISE EN GARDE	Avertit d'un danger corporel. Le non-respect de cette mise en garde peut provoquer des blessures graves, voire mortelles.

Pictogramme / label	Signification
 ATTENTION	Avertit d'un danger corporel et matériel. Le non-respect de cette mise en garde peut provoquer des blessures graves et des dommages matériels.
 EX	Avertit de la présence d'une atmosphère explosive.

2 Sécurité

2.1 Personnel – qualification

L'utilisation du système est soumise au règlement de sécurité du travail et aux dispositions relatives aux produits dangereux s'y rapportant en vigueur ou aux dispositions des ouvrages équivalents sur le plan national.

L'exploitant du système est tenu :

- ▶ d'établir une évaluation des risques,
- ▶ de déterminer les zones à risques s'y rapportant et d'attirer l'attention sur ces zones,
- ▶ de veiller à la mise en pratique de formations se rapportant aux consignes de sécurité,
- ▶ de le protéger contre l'utilisation par des personnes non autorisées.

Personne ¹⁾	Activités autorisées sur les systèmes KESSEL		
Exploitant	Contrôle visuel, inspection		
Technicien spécialisé (connaît et comprend les instructions d'utilisation)		Contrôle fonctionnel, configuration du gestionnaire	
Électricien VDE 0105 (selon les prescriptions de sécurité électrique ou les dispositions nationales)			Travaux sur l'installation électrique

1) L'utilisation et le montage sont réservés au domaine de compétence de personnes âgées de 18 ans révolus.

2.2 Consignes de sécurité générales



AVIS

Activer le système !



- ▶ S'assurer que les appareils électriques sont coupés de l'alimentation en tension pendant les travaux.
- ▶ Sécuriser les appareils électriques contre leur remise en marche.



AVERTISSEMENT

Pièces sous tension ! Seul un électricien qualifié est autorisé à ouvrir le boîtier du gestionnaire !

Les activités sur le gestionnaire sont limitées :

- ▶ à la mise en circuit du contacteur-interrupteur et l'adaptation du disjoncteur du moteur,
- ▶ au remplacement des batteries,
- ▶ au raccordement dans le respect des instructions de montage et du schéma de raccordement.

Tous les travaux dépassant ce cadre sont réservés au domaine de compétence du service après-vente KESSEL ou d'un partenaire du service après-vente de KESSEL SE + Co. KG.



AVERTISSEMENT

Pièces sous tension

Respecter les instructions suivantes lors de travaux sur des câbles et raccordements électriques.

- ▶ Les directives nationales de sécurité électrique s'appliquent à tous les raccordements et travaux d'installation sur le système.
- ▶ Le système doit être alimenté par un dispositif différentiel à courant résiduel (RCD) avec courant assigné de défaut d'une sensibilité au plus égale à 30 mA.



Les instructions d'utilisation et de maintenance doivent être tenues à disposition avec le produit.



AVIS

Nettoyage inapproprié

Les composants en composite peuvent être endommagés ou fragilisés

- ▶ Nettoyer les composants en composite exclusivement avec de l'eau et un produit de nettoyage au pH neutre.

2.3 Utilisation conforme à l'usage prévu

Le gestionnaire reproduit la commande d'un poste de relevage ou d'une station de relevage pour eaux usées. Des interrupteurs à flotteur sont utilisés pour la détection du niveau. Le pompage est activé dès l'atteinte du niveau de commutation. Le pompage s'arrête automatiquement dès que le niveau est à nouveau inférieur au niveau défini.

En fonction de la variante, le gestionnaire est prévu pour une pompe (Mono) ou deux pompes (Duo).



AVERTISSEMENT

Le gestionnaire en soi N'EST PAS prévu pour un montage dans une zone EX !

Le gestionnaire comprend un équipement électrique correspondant pour les circuits à sécurité intrinsèque.

Toutes les interventions non expressément autorisées par écrit par le fabricant, notamment les

- écarts par rapport aux spécifications techniques
- transformations ou pièces annexées
- utilisations de pièces de rechange non originales
- réparations exécutées par des entreprises ou personnes non dûment autorisées par le fabricant

peuvent mettre fin à tout recours à la garantie du fabricant.

Remarques concernant le positionnement des armoires électriques extérieures





AVERTISSEMENT

Dépassement de la température de fonctionnement maximale autorisée

Panne possible du gestionnaire

- ▶ Tenir compte de l'emplacement de montage de l'armoire électrique extérieure.
- ▶ Évaluer l'exposition au soleil sur l'emplacement de montage.
- ▶ Tenir compte des conditions ambiantes sur site.

Le tableau suivant donne un aperçu des mesures requises :

	<p>Forte exposition au soleil de 8 heures ou plus à intervalles réguliers et/ou accumulation d'air chaud</p>	<p>Montage d'un kit de dispositif de refroidissement pour armoires électriques extérieures (réf. 681148) nécessaire.</p>
	<p>Exposition au soleil occasionnellement importante, à intervalles non réguliers</p>	<p>Montage nécessaire d'un ventilateur disponible dans le commerce avec détection de la température afin de ventiler l'intérieur. Il convient d'activer le ventilateur à partir d'une température intérieure de 40 °C dans l'armoire électrique.</p>
	<p>Emplacement de montage toujours ombragé et/ou conditions ambiantes avec de faibles écarts de température</p>	<p>Aucune mesure requise.</p>

2.3.1 Aperçu des sous-groupes et des fonctions

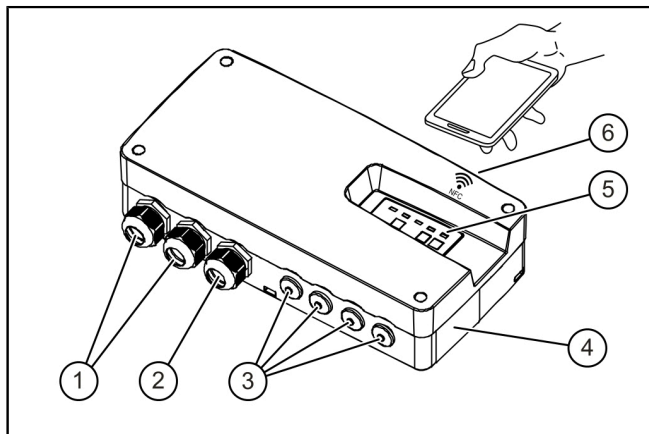

(1)	Raccords pour pompe(s)
(2)	Câble d'alimentation
(3)	Bouchons, raccords optionnels
(4)	Plaque signalétique
(5)	Voyants et panneau de commande
(6)	NFC

2.3.2 Affichages, touches de commande et leurs fonctions

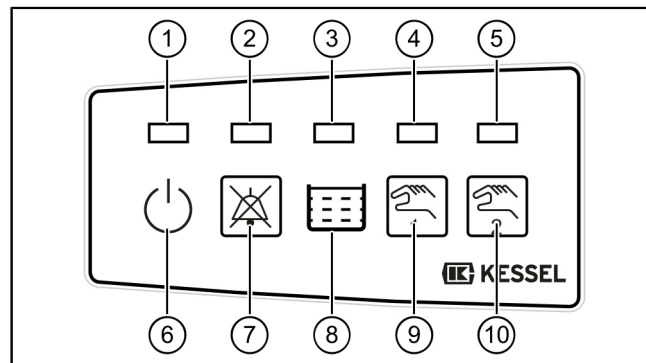

(1)	Voyant état opérationnel (vert)
(2)	Diode d'alarme (rouge)
(3)	Voyant d'atteinte du niveau de commutation (orange)
(4)	Voyant de fonctionnement de la pompe (orange)
(5)	Voyant de fonctionnement de la pompe (orange), (Duo uniquement)
(6)	Pictogramme En service
(7)	Touche extinction de l'alarme (acquiescement)
(8)	Pictogramme Cuve
(9)	Touche fonctionnement pompe (mode manuel)
(10)	Touche fonctionnement pompe (mode manuel), (Duo uniquement)

3 Caractéristiques techniques

Indication	Mono	Duo
Puissance maximale à la sortie de commutation (pour $\cos \varphi = 1$)	4 kW	2 x 4 kW
Plage de courant nominal	2,5 à 6 A	2,5 - 6 A*
Poids	1 kg	1,3 kg
Dimensions (LxlxH)	234 x 184 x 75 mm	305 x 184 x 75 mm
Tension de service	400 volts / 50 Hz	
Puissance en veille	2 W	
Contact sec	maximum 42 volts CC / 0,5 A	
Spécification de la batterie	9 V 6LR61	
Plage de température	0 - 50 °C	
Humidité relative [%] (sans condensation)	max. 90 %	
Indice de protection	IP 54	
Classe de protection	I	
Fusible requis, A, (Mono)	C16	C16 (C20**)
RCD	30 mA	

Titre

* Les postes Duo sont équipés de deux pompes dotées de caractéristiques techniques identiques.

** dans le cas de pompes dont la plage de courant nominal totale déclarée est supérieure à 5 A

4 Montage

4.1 Montage du gestionnaire

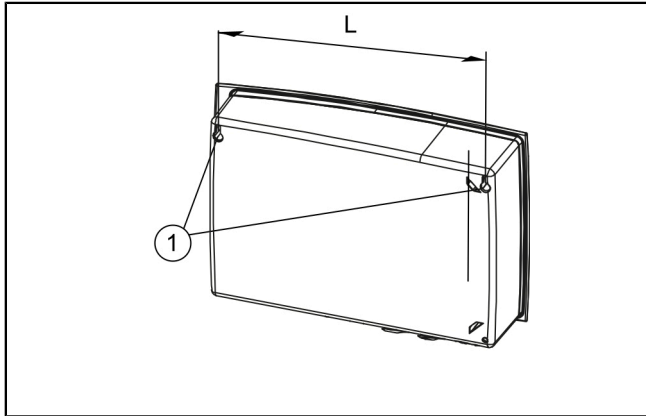

(L)	Mono : distance de centre à centre de l'orifice 208 mm
	Duo : distance de centre à centre de l'orifice 277 mm

- ▶ Choisir l'emplacement prévu au montage en veillant aux points suivants :
 - Proximité immédiate du gestionnaire d'une alimentation électrique adaptée.
 - Le gestionnaire doit être accessible, sa fixation doit être fiable et suffisante.

▶ Monter toutes les vis de fixation. S'assurer à cet effet que l'écart entre les têtes des vis et l'embase soit d'environ 3 - 4 mm.

▶ Accrocher le gestionnaire aux vis de fixation et le pousser légèrement vers le bas.

ⓘ Le gestionnaire est exclusivement destiné à un montage en intérieur ou dans une armoire électrique extérieure KESSEL.

Il ne doit pas être exposé aux rayons directs du soleil et doit être installé dans un environnement sec, bien aéré et à l'abri du gel.

4.2 Schéma de raccordement

Selon la variante, veuillez utiliser le schéma de raccordement correspondant.

Schéma de raccordement Mono 400V : Aquapump Small Mono et Aqualift L Mono	<i>cf. "Schéma de raccordement Mono", page 137</i>
Schéma de raccordement Duo 400V : Aquapump Small Duo	<i>cf. "Schéma de raccordement Duo", page 138</i>
Schéma de raccordement Duo 400V : Aqualift L Duo	<i>cf. "Schéma de raccordement Duo Aqualift L", page 139</i>

4.3 Raccordement électrique

**DANGER**

Risque dû au dimensionnement erroné des conduites de raccordement.

Le système est exclusivement prévu pour une utilisation avec les conduites de raccordement fournies (ou des conduites équivalentes). Demander conseil au fabricant / fournisseur en cas de doute.

- Poser les câbles de raccordement correctement de la cuve jusqu'au gestionnaire (se servir p. ex. d'un fourreau pour câbles). Prévoir suffisamment de longueur de câble pour pouvoir effectuer des opérations de maintenance sur les composants électriques.

► Monter les embouts (longueur de 8 mm) aux extrémités des câbles.

► Dévisser et retirer le couvercle du boîtier.

Mono/Duo : 4 vis à chaque angle du couvercle du boîtier

► Guider le câble de raccordement à travers le passage de câble correspondant et ouvrir si besoin les points de rupture pour les passages de câbles requis. ❶



AVIS

Observer l'indice IP54

- Se servir d'un outil pour casser les caches destinés aux passages de câble. ❷
- Enfoncer les passages de câble en caoutchouc dans les ouvertures. ❸
- Couper les embouts des passages de câble utilisés. ❹
- Fixer le câble de raccordement suivant le schéma de raccordement aux borniers.
Pour ce faire, se servir d'un tournevis plat approprié pour abaisser la borne de câble correspondante contre la pression de ressort jusqu'à pouvoir introduire l'extrémité du câble. ❺

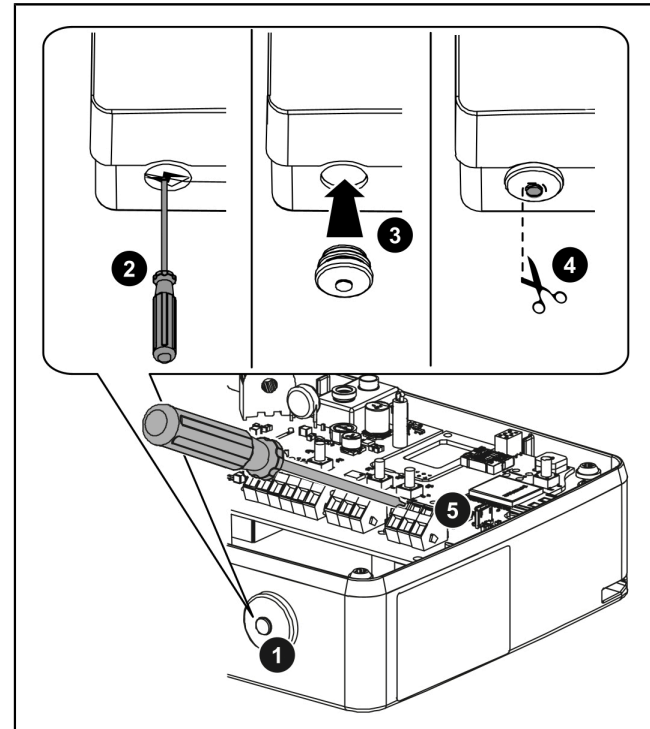

- ▶ Poser les câbles de raccordement correctement de la cuve jusqu'au gestionnaire (se servir p. ex. d'un fourreau pour câbles). Prévoir suffisamment de longueur de câble pour pouvoir effectuer des opérations de maintenance sur les composants électriques.
- ▶ Brancher la batterie. **6**
- ▶ Poser le câble de la batterie de manière à ne pas recouvrir ni coincer les voyants.
- ▶ Munir tous les câbles de raccordement d'une décharge de traction, couple de serrage 0,5 Nm. **7**
- ▶ Mettre le couvercle du boîtier en place et le fixer, couple de serrage des vis de 1,2 Nm.

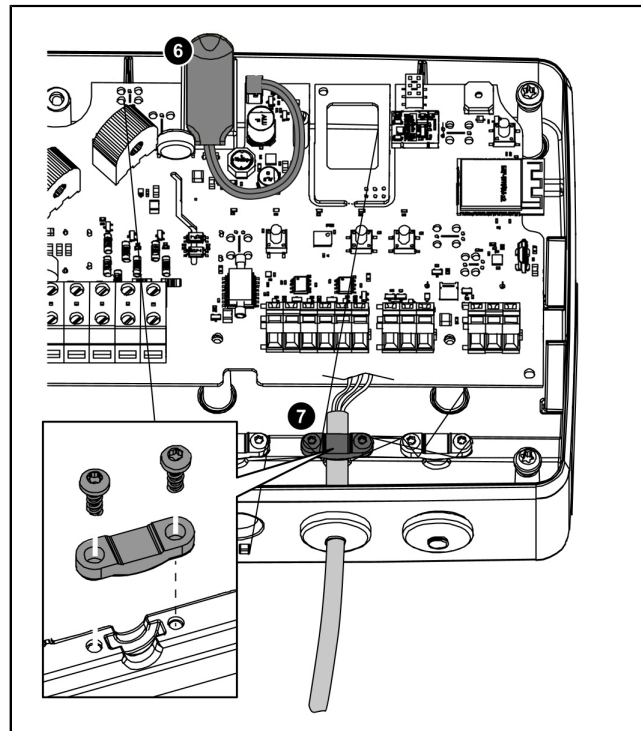

5 Fonctionnement

5.1 Mode automatique

Le poste fonctionne en mode automatique lorsqu'aucun défaut n'a été détecté et que le voyant de fonctionnement vert (1) est allumé.

La pompe démarre et s'arrête suivant le niveau des eaux usées.

Sur les gestionnaires 400V Mono/Duo, il est possible de consulter le journal d'exploitation du gestionnaire, de synchroniser la date et l'heure et de régler divers paramètres avec l'appli NFC de KESSEL et avec un terminal compatible NFC (par ex. téléphone portable).

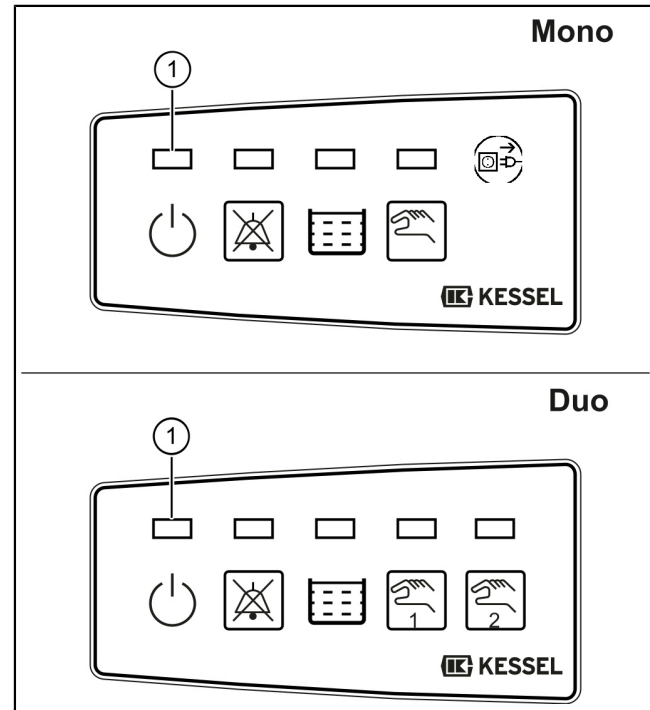

5.2 États d'alarme

Alarme de trop-plein de la cuve

- Le dépassement du niveau d'alarme (interrupteur à flotteur) dans la cuve déclenche une alarme, le voyant d'alarme (2) clignote et un signal acoustique retentit. La pompe démarre.
- L'acquiescement de cet état d'alarme est impossible et il ne disparaît qu'après un pompage réussi. Le signal acoustique peut être désactivé (en appuyant brièvement sur la touche d'alarme).

Alarme de panne de secteur

- En cas de panne de secteur, le voyant d'alimentation vert (1) s'éteint après une seconde, le voyant d'alarme (2) clignote et un signal acoustique périodique retentit. Une mise en marche de la pompe est impossible.
- Le gestionnaire ne signale plus cet état d'alarme dès que l'alimentation électrique est rétablie et le système refonctionne en mode automatique.

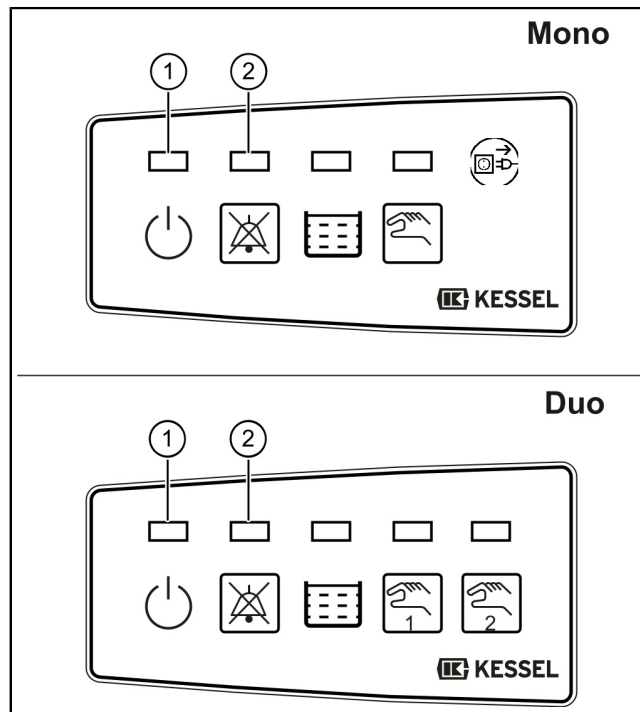

5.3 Mode manuel

Le mode manuel peut être activé via la touche (9) / (10). La pompe n'est plus automatiquement mise en service dans ce cas.

L'actionnement du mode manuel pendant le pompage a pour effet de mettre la pompe hors service.

Activation du mode manuel

- ▶ Actionner la touche (9) / (10), le voyant orange du mode manuel (4) / (5) clignote.

La mise en service de la pompe est possible comme suit si le mode manuel est activé :

Mise en service de courte durée

- ▶ Appuyer 1 fois sur la touche (9) / (10).
- ✓ La pompe est activée brièvement.

Activation de plus longue durée



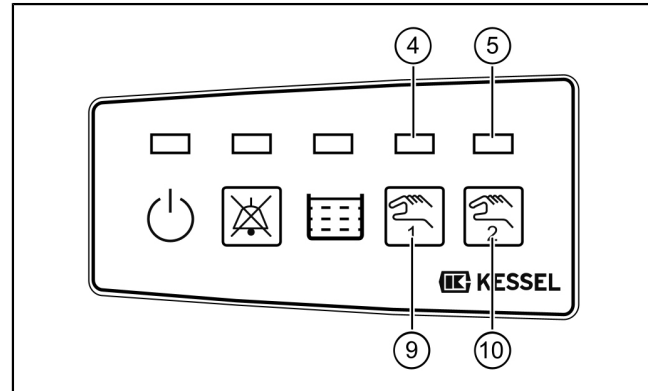

- ▶ Appuyer sur la touche (9) / (10) et la maintenir enfoncée tant que la pompe doit rester activée.
- ✓ La pompe est activée.

① Le gestionnaire active le mode automatique si le mode manuel n'est pas utilisé pendant plus de 5 minutes.



5.4 Aperçu des voyants d'affichage - informations





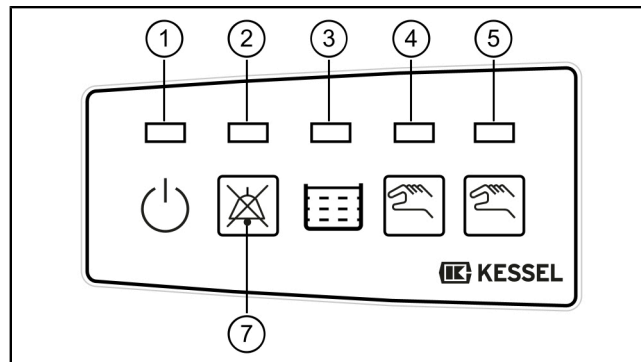



Motif de clignotement des diodes 1 - 5*





-  Clignotent
-  S'allument / activées
-  Désactivées
-  Clignotent en alternance
-  Clignotent simultanément
- 5* Uniquement avec Aqualift L DUO



FR

États de service

Diode				Signal sonore (intervalle)	Contact sec ¹	Description	Action
 vert (1)	 rouge (2)	 orange (3)	 orange (4) / (5*)				
				-	-	Hors service, pas de surveillance de la batterie ²	Rétablir la tension de réseau





















Diode				Signal sonore (intervalle)	Contact sec ¹	Description	Action
 vert (1)	 rouge (2)	 orange (3)	 orange (4) / (5*)				
●	○	○	○	-	-	Prêt à fonctionner	-
●	○	●	◐	-	-	Cuve pleine, le pompage démarre sous peu	Aucune démarche n'est requise, il suffit de désactiver la pompe via l'actionnement de la touche (8) (cf. "Mode manuel", page 61)
●	○	●	●	-	-	Pompage de la cuve en cours	





¹ Le contact sec est activé (la réf. 80074 doit au préalable être activée et raccordée).

² La surveillance de la batterie n'est active que si une batterie a été raccordée lors de la mise en service.

5* Uniquement avec Aqualift L DUO

États d'alarme / erreurs
FR

Diode				Signal sonore (intervalle)	Contact sec ¹	Description	Action
vert (1)	rouge (2)	orange (3)	orange (4)/ (5*)				
				✓	Oui	Défaut de la batterie ²	Remplacer la batterie
				✓	Oui	Panne de secteur, absence de tension de réseau, le poste ne fonctionne pas	Rétablir la tension de réseau, acquitter l'alarme
				✓	Oui	Erreur de niveau, détection d'un ordre d'apparition illogique du niveau	Acquitter l'alarme- contrôler l'arrivée, vérifier le dispositif anti-retour, erreur niveau - vérifier l'interrupteur à flotteur.
				✓	Oui	Durée / nombre limite de marche, mise en service trop fréquente de la pompe ou de trop longue durée	
				✓	Oui	Dépassement du niveau d'alarme	Patienter jusqu'à ce que le niveau d'alarme ne soit plus dépassé

Diode				Signal sonore (intervalle)	Contact sec ¹	Description	Action
vert (1)	rouge (2)	orange (3)	orange (4)/(5*)				
				-	-	Dépassement du nombre maximal de cycles de commutation	Acquitter l'alarme et remplacer le gestionnaire

¹ Le contact sec est activé.

² La surveillance de la batterie n'est active que si une batterie a été raccordée lors de la mise en service.

5* Uniquement avec Aqualift L DUO

Acquittement de l'alarme

Si un état déclenche une alarme, cela est signalé par l'allumage du voyant d'alarme (2) et éventuellement de l'un des autres voyants. Éliminer la cause de l'alarme, puis acquitter l'alarme en appuyant sur la touche (7).

Désactivation de l'alarme acoustique

► Appuyer 1 fois sur la touche (7)

Acquittement de l'alarme

► Maintenir la touche (7) enfoncée pendant plus de 3 secondes.

✓ L'affichage d'alarme s'éteint et l'alarme est acquittée.

5.5 Lire les données et régler les paramètres





Il est possible de consulter le journal d'exploitation du gestionnaire, de synchroniser la date et l'heure et d'ajuster divers paramètres avec l'appli NFC de KESSEL et avec un terminal compatible NFC (par ex. téléphone portable).



AVERTISSEMENT

Mettre le gestionnaire en service avant d'utiliser l'appli cf. "*Chapitre Fonctionnement*", page 59.

FR

Apple Store	Google Play Store
 	 
https://apps.apple.com/de/app/kessel-nfc/id6449256249	https://play.google.com/store/apps/details?id=com.kessel.nfcapp&gl=DE

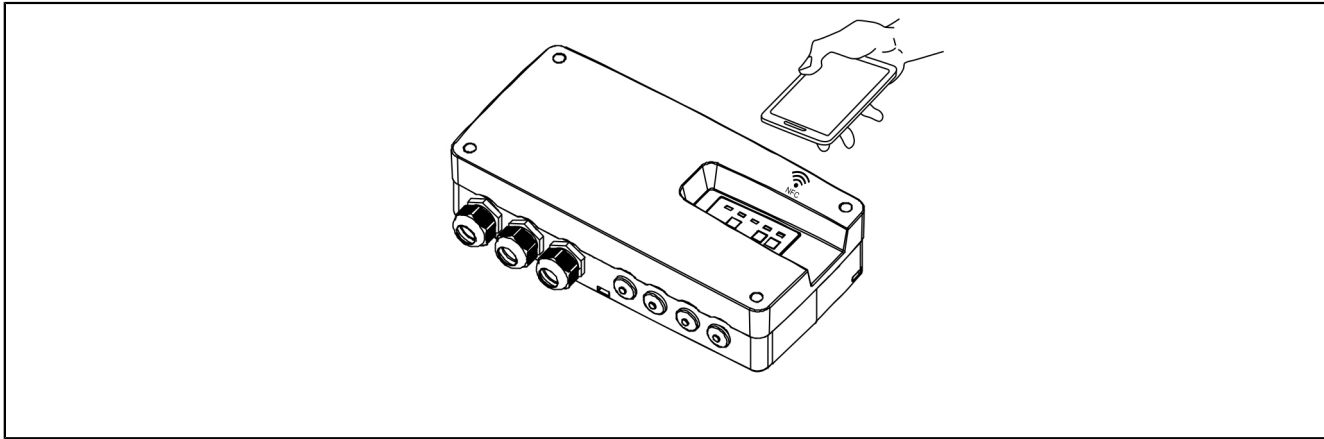

Fig.: Terminal - Smartphone

Consulter les données du gestionnaire

Pour cela, le terminal compatible NFC doit se trouver directement au niveau du gestionnaire ("*fig. Terminal-Smartphone*").

Afficher et éditer les paramètres :

Ceux-ci peuvent être copiés et envoyés par mail. (mot de passe 1000)

5.6 Synchroniser la date/l'heure

Transférer les valeurs de l'appareil compatible NFC au gestionnaire.

5.7 Arrêt du poste

- ▶ Activer le système.
 - ▶ Appuyer sur la touche d'alarme (7) sans relâcher jusqu'à ce que le voyant d'alarme (2) ne clignote plus. Le gestionnaire s'arrête alors automatiquement.
- ① Le branchement de la batterie est désactivé tant que le gestionnaire est déconnecté. Un déchargement de la batterie connectée est exclu. L'initialisation requiert une tension de réseau qui permet de réactiver le branchement de la batterie.

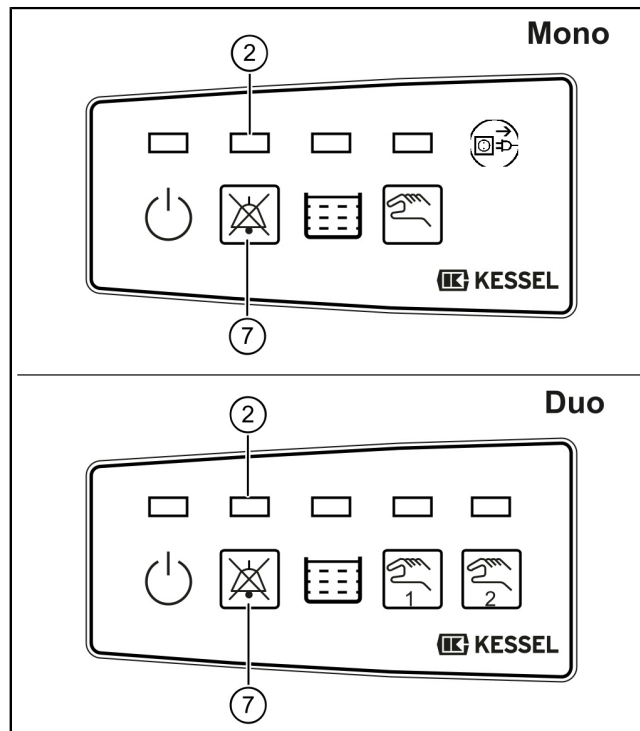

Istruzioni per l'installazione e l'uso

Indice

1	Indicazioni sulle presenti istruzioni.....	70
2	Sicurezza.....	71
3	Dati tecnici.....	77
4	Montaggio.....	78
5	Funzionamento.....	82

Cara cliente, caro cliente,

in qualità di produttore premium di prodotti innovativi per la tecnica di drenaggio, KESSEL offre soluzioni di sistema integrate e un servizio orientato al cliente. Puntiamo sui massimi standard qualitativi e ci impegniamo coerentemente per la sostenibilità – non ci impegniamo solo nella produzione dei nostri prodotti, ma anche rispetto al funzionamento a lungo termine, in modo che la vostra proprietà sia protetta nel tempo.

KESSEL SE + Co. KG

Bahnhofstraße 31

85101 Lenting, Germania



In caso di domande di carattere tecnico, i nostri partner di servizio qualificati sul posto saranno felici di aiutarvi.

Potete trovare i vostri referenti alla pagina:

www.kessel.de/kundendienst



In caso di necessità, il nostro centro di assistenza dell'azienda vi supporta con servizi come la messa in funzione, la manutenzione o l'ispezione generale in tutta la regione DACH e in altri Paesi a richiesta. Per le informazioni sullo svolgimento e sull'ordine consultate la pagina



www.kessel.de/service/dienstleistungen



1 Indicazioni sulle presenti istruzioni

Il presente documento costituisce le istruzioni per l'uso originali. La lingua delle istruzioni per l'uso originali è il tedesco. Tutte le versioni in altre lingue di queste istruzioni costituiscono delle traduzioni.

Le seguenti convenzioni illustrative semplificano l'orientamento:

Simbolo	Spiegazione
[1]	vedere figura 1
(5)	Posizione numero 5 della figura accanto
1 2 3 4 5 ...	Passaggio procedurale nella figura
 Controllare se il funzionamento manuale è stato attivato.	Presupposti per l'azione
 Premere OK.	Passaggio procedurale
✓ L'impianto è pronto per funzionare.	Risultato dell'azione
vd. "Sicurezza ", pagina 71	Rimando al capitolo 2
Grassetto	Informazioni particolarmente importanti o rilevanti per la sicurezza
<i>Corsivo</i>	Versione o informazione supplementare (ad esempio in caso di validità per la sola versione ATEX)

Simbolo	Spiegazione
	Avvertenza tecnica che richiede particolare attenzione.

Sono impiegati i simboli seguenti:

Simbolo	Significato
	Mettere fuori tensione l'apparecchio!
	Prestare attenzione all'istruzione per l'uso
	Marchio CE
	Attenzione, elettricità
	Simbolo WEEE, prodotto soggetto alla direttiva RoHS
 ATTENZIONE	Avverte circa un pericolo per le persone. La mancata osservanza di questa avvertenza può causare lesioni gravissime o provocare la morte.
 PRUDENZA	Avverte circa un pericolo per le persone e il materiale. La mancata osservanza di questa avvertenza può causare lesioni gravi o provocare danni materiali.

Simbolo	Significato
	Avverte della presenza di atmosfere esplosive.

2 Sicurezza

2.1 Personale – Qualifica

Per il funzionamento dell'impianto valgono l'ordinanza sulla sicurezza operativa e l'ordinanza sulle sostanze pericolose rispettivamente valide o le norme nazionali equivalenti.

L'operatore dell'impianto ha inoltre l'obbligo di:

- ▶ effettuare una valutazione dei rischi,
- ▶ determinare e segnalare delle zone di rischio adeguate,
- ▶ effettuare la formazione per la sicurezza,
- ▶ impedire l'uso da parte di persone non autorizzate.

Persona ¹⁾	Mansioni ammesse sugli impianti KESSEL		
Esercente	Controllo visivo, ispezione		
Esperto (conosce e comprende le istruzioni per l'uso)		Controllo del funzionamento, configurazione della centralina	
Elettricista specializzato VDE 0105 (nel rispetto delle norme per la sicurezza elettrica o delle norme nazionali equivalenti)			Lavori all'installazione elettrica

1) Comando e montaggio possono essere affidati solo a persone che hanno compiuto il 18° anno di età.



**AVVISO****Mettere fuori tensione l'impianto!**

- ▶ Accertare che gli apparecchi elettrici siano separati dall'alimentazione di tensione durante i lavori.
- ▶ Assicurare gli apparecchi elettrici contro la riaccensione.

**AVVERTENZA**

Parti conducenti tensione! L'alloggiamento della centralina può essere aperto solo da un elettricista specializzato!

Le mansioni sulla centralina sono limitate:

- ▶ accensione del contatore e regolazione del salvamotore,
- ▶ alla sostituzione delle batterie,
- ▶ collegamento secondo le istruzioni di installazione e lo schema di collegamento.

Tutti i lavori diversi da quelli elencati devono essere eseguiti esclusivamente dal servizio clienti KESSEL o da un partner di assistenza della KESSEL SE + Co. KG.

**AVVERTENZA****Parti conducenti tensione**

- Per i lavori alle linee elettriche e ai collegamenti elettrici, tenere in considerazione quanto segue.
- ▶ Per tutti i lavori di collegamento e installazione sull'impianto trovano applicazione le norme nazionali sulla sicurezza elettrica.
 - ▶ L'impianto deve essere alimentato tramite un interruttore differenziale con una corrente di guasto nominale non superiore a 30 mA.



Le istruzioni per l'uso e la manutenzione devono essere disponibili presso il prodotto.

**AVVISO****Pulizia impropria**

- I componenti in plastica possono danneggiarsi o diventare fragili
- ▶ Pulire i componenti in plastica esclusivamente con acqua e un detergente a pH neutro.

2.3 Conforme alla destinazione d'uso

La centralina costituisce il comando di un impianto di sollevamento o di una stazione di pompaggio per le acque di scarico. Per la rilevazione del livello sono utilizzati gli interruttori a galleggiante. Al raggiungimento del livello di commutazione, viene attivato il pompaggio di svuotamento. Il pompaggio di svuotamento si interrompe automaticamente dopo l'abbassamento del livello dell'acqua.

A seconda della versione, la centralina è progettata per una pompa (Mono) o due pompe (Duo).



AVVERTENZA

La centralina NON è pensata per l'installazione in una zona potenzialmente esplosiva!
La centralina contiene un dispositivo elettrico adeguato per circuiti a sicurezza intrinseca.

Di seguito le operazioni non espressamente autorizzate per iscritto dal produttore:

- Deviazioni dalle specifiche tecniche
 - Modifiche o aggiunte
 - Utilizzo di ricambi non originali
 - Riparazioni effettuate da società o persone non autorizzate dal produttore
- possono invalidare la garanzia.





Indicazioni per il posizionamento delle cabine esterne per quadro elettrico**AVVERTENZA****Superamento della temperatura operativa massima consentita**

Possibile malfunzionamento della centralina

- ▶ Tenere conto del luogo di montaggio della cabina esterna per il quadro elettrico.
- ▶ Valutare l'influsso del sole nel luogo di montaggio.
- ▶ Tenere conto delle condizioni ambientali locali.

La tabella seguente fornisce una visione d'insieme delle misure necessarie:

	Occorre prevedere un'esposizione regolare e intensa alla luce solare di 8 ore o più e/o l'accumulo di aria ambiente riscaldata	Il montaggio dell'apparecchio di refrigerazione per le cabine esterne per quadro elettrico (codice articolo 681148) è necessario.
	È da attendersi un irraggiamento solare irregolare, temporaneamente intenso	È necessario il montaggio di un comune ventilatore con rilevamento della temperatura per l'aerazione del vano interno. L'areazione dovrebbe attivarsi a partire da una temperatura interna del quadro elettrico di 40 °C.
	Luogo di montaggio sempre in ombra e/ o condizioni ambientali con oscillazioni di temperatura ridotte	Non sono necessarie misure di nessun tipo.

2.3.1 Gruppi costruttivi e visione d'insieme del funzionamento

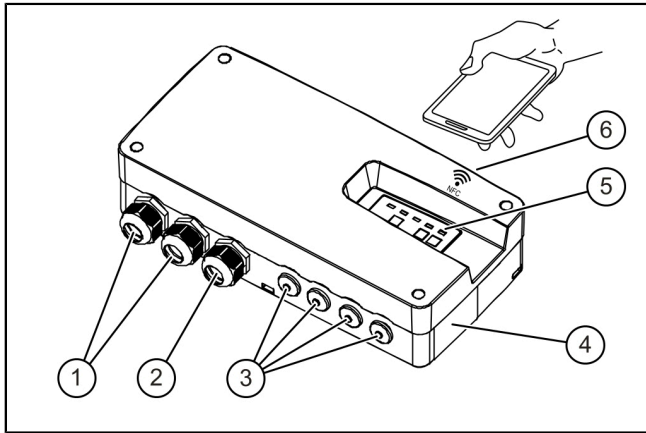

(1)	Collegamento per pompa/e
(2)	Cavo di alimentazione
(3)	Tappo cieco, collegamenti opzionali
(4)	Targhetta
(5)	LED e quadro di comando
(6)	NFC

2.3.2 Visualizzazioni, tasti di comando e loro funzioni

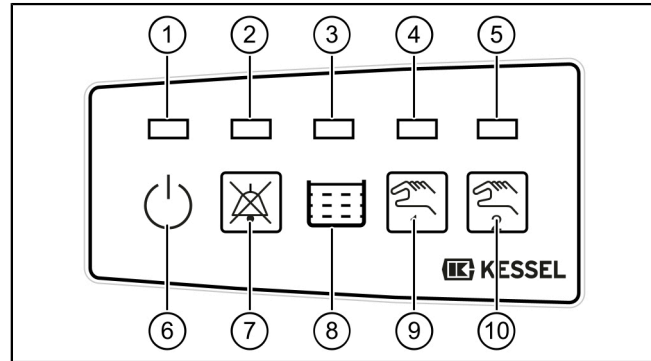

(1)	LED Prontezza al funzionamento (verde)
(2)	LED di allarme (rosso)
(3)	LED Livello di accensione raggiunto (arancio)
(4)	LED Pompa delle acque di scarico in funzione (arancio)
(5)	LED Pompa delle acque di scarico in funzione (arancio), (solo Duo)
(6)	Simbolo di funzionamento
(7)	Tasto di spegnimento dell'allarme (conferma)
(8)	Simbolo del contenitore dell'impianto
(9)	Tasto della pompa delle acque di scarico ON (manuale)
(10)	Tasto della pompa delle acque di scarico ON (manuale), (solo Duo)



3 Dati tecnici

Indicazione	Mono	Duo
Potenza massima all'uscita di commutazione (con $\cos \varphi = 1$)	4 kW	2 x 4 kW
Gamma di corrente nominale	2,5 - 6 A	2,5 - 6 A*
Peso	1 kg	1,3 kg
Misure (Lu x La x Pr)	234x184x75 mm	305x184x75 mm
Tensione di funzionamento	400 V / 50 Hz	
Potenza, stand-by	2 W	
Contatto a potenziale zero	max. 42 V DC / 0,5 A	
Specifica della batteria	9 V 6LR61	
Temperatura d'impiego	0 - 50 °C	
Umidità dell'aria relativa [%] (senza condensa)	max 90 %	
Tipo di protezione	IP54	
Classe di protezione	I	
Fusibile necessario, A, (Mono)	C16	C16 (C20**)
RCD	30 mA	

* Gli impianti Duo dispongono di due pompe con dati tecnici identici.

** nelle pompe con gamma di corrente nominale dichiarata complessivamente superiore a 5 A



4 Montaggio

4.1 Montaggio della centralina

- ▶ Scegliere la posizione di montaggio accertando che:
 - Sia presente una fonte di alimentazione idonea nelle immediate vicinanze della centralina.
 - La centralina deve essere accessibile, sicura e adeguatamente fissata.

- ▶ Montare tutte le viti di fissaggio. Assicurarsi che la distanza tra le teste delle viti e la superficie di fissaggio sia pari a circa 3 – 4 mm.

- ▶ Appendere la centralina alle viti di fissaggio e premere leggermente verso il basso.

- ① La centralina è progettata esclusivamente per l'installazione all'interno dell'edificio o in una cabina esterna per quadro elettrico KESSEL.

Non deve essere esposta alla luce diretta del sole e deve essere installata in un ambiente asciutto, ben ventilato e protetto dal gelo.

4.2 Schema di collegamento

A seconda del prodotto deve essere utilizzato il rispettivo schema di collegamento.

Schema di collegamento Mono 400 V: Aquapump Small Mono e Aqualift L Mono

vd. "Schema di collegamento Mono ",
pagina 137

Schema di collegamento Duo 400 V: Aquapump Small Duo

vd. "Schema di collegamento Duo",
pagina 138

Schema di collegamento Duo 400 V: Aqualift L Duo

vd. "Schema di collegamento Duo Aqualift L",
pagina 139

4.3 Collegamento elettrico



PERICOLO

Pericolo a causa del dimensionamento errato dei condotti di collegamento.

L'impianto è destinato esclusivamente al funzionamento con i condotti di collegamento in dotazione (o analoghi). In caso di dubbio, contattare il produttore / fornitore.

- Posare il cavo di collegamento in modo sicuro dal serbatoio alla centralina (ad esempio attraverso il tubo per cavi). Lasciare una lunghezza del cavo sufficiente per consentire la manutenzione dei componenti elettrici.

- ▶ Applicare i capicorda (lunghezza di 8 mm) alle estremità dei cavi.
- ▶ Allentare e togliere il coperchio dell'alloggiamento.

Mono/Duo: 4 viti in ogni angolo del coperchio dell'alloggiamento

- ▶ Fare passare il cavo attraverso l'apposito passante per cavi, eventualmente aprire i punti di rottura stabiliti in corrispondenza dei passanti per cavi previsti. ❶



AVVISO

Rispettare la norma IP54

- ▶ Sfondare i passanti per cavi con un utensile adatto. ❷
- ▶ Inserire i passanti per cavi di gomma nelle aperture. ❸
- ▶ Tagliare via i nippli dei passanti per cavi impiegati. ❹
- ▶ Fissare il cavo di collegamento alla morsettiera nel rispetto dello schema di collegamento.

A tale fine, tenere premuto il rispettivo morsetto per cavo contro la forza della molla con un cacciavite adatto, fino a che l'estremità del cavo è innestata. ❺

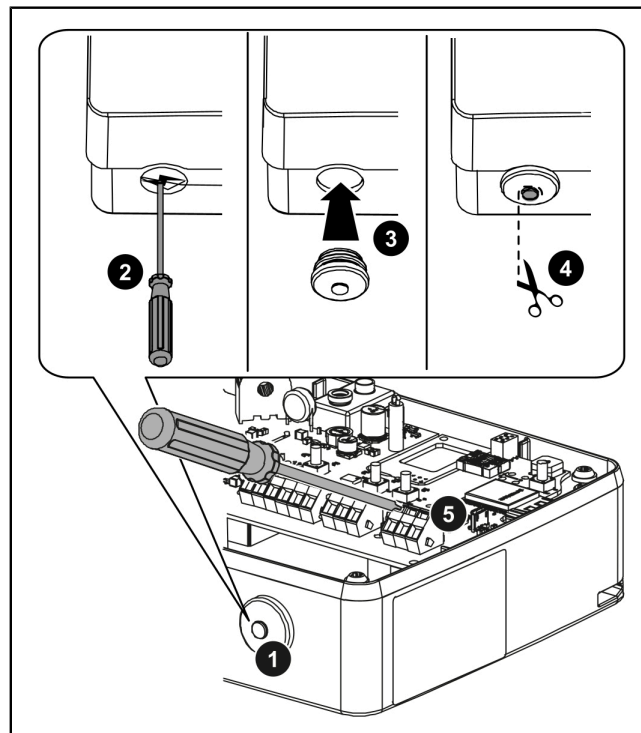

- ▶ Posare il cavo di collegamento in modo sicuro dal serbatoio alla centralina (ad esempio attraverso il tubo per cavi). Lasciare una lunghezza del cavo sufficiente per consentire la manutenzione dei componenti elettrici.
- ▶ Connettere il connettore della batteria alla batteria. **6**
- ▶ Posare il cavo della batteria in modo che i LED non siano coperti o incastrati.
- ▶ Fissare gli scarichi della trazione per tutti i cavi di collegamento, momento di serraggio di 0,5 Nm. **7**
- ▶ Applicare il coperchio dell'alloggiamento e fissarlo, momento di serraggio delle viti di 1,2 N m.

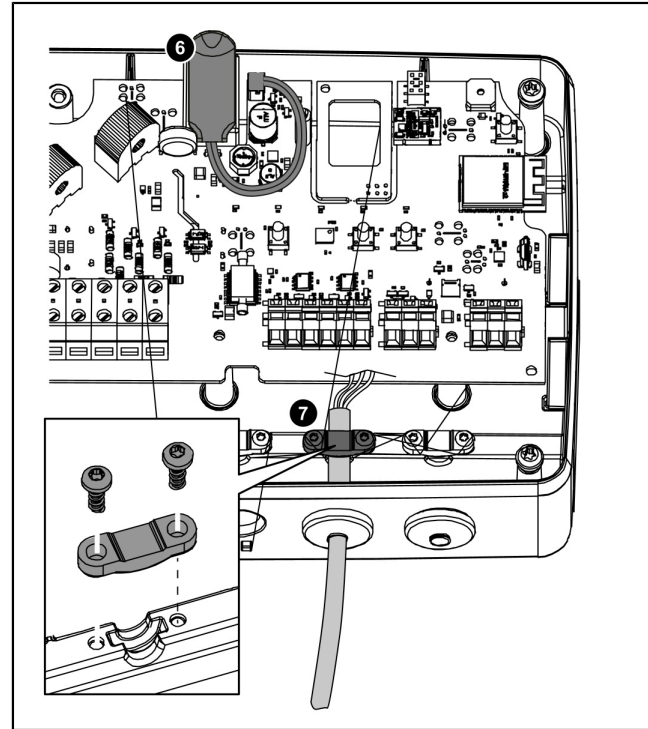

5 Funzionamento

5.1 Funzionamento automatico

L'impianto si trova in modalità di funzionamento automatico se non viene rilevato alcun errore e se il LED di funzionamento (1) è verde.

La pompa delle acque di scarico viene accesa e spenta in base al livello delle acque reflue.

Con le centraline da 400 V Mono/Duo, con l'app KESSEL NFC e un dispositivo terminale abilitato alla NFC (ad esempio un telefono cellulare), è possibile leggere il diario d'esercizio della centralina, sincronizzare la data e l'ora e modificare diversi parametri.

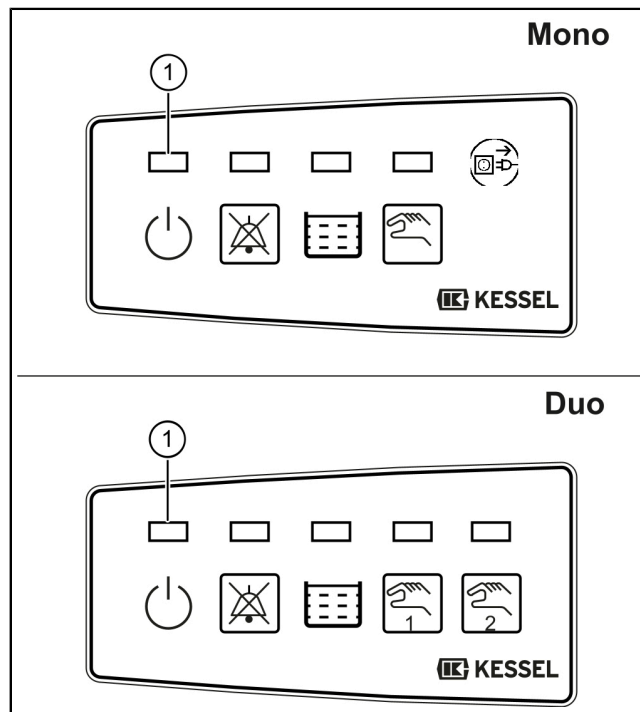

5.2 Stati d'allarme

Allarme: contenitore dell'impianto troppo pieno

- Se il livello dell'acqua nel contenitore dell'impianto supera il livello d'allarme (interruttore a galleggiante), viene attivato l'allarme, si accende il LED d'allarme (2) e viene emesso un segnale acustico. La pompa delle acque di scarico funziona.
- Lo stato d'allarme non può essere confermato, viene spento solo in caso di pompaggio di svuotamento riuscito. Il segnale acustico può essere spento (premendo brevemente sul tasto d'allarme).

Allarme: alimentazione di corrente mancante

- Se l'alimentazione di tensione viene a mancare, il LED di funzionamento verde (1) si spegne dopo pochi secondi, il LED d'allarme (2) lampeggia e viene generato un segnale acustico ricorrente. La pompa delle acque di scarico non può più essere accesa.
- Al ritorno dell'alimentazione di tensione, la centralina non visualizza più questo stato di allarme e l'impianto torna a funzionare come nel funzionamento automatico.

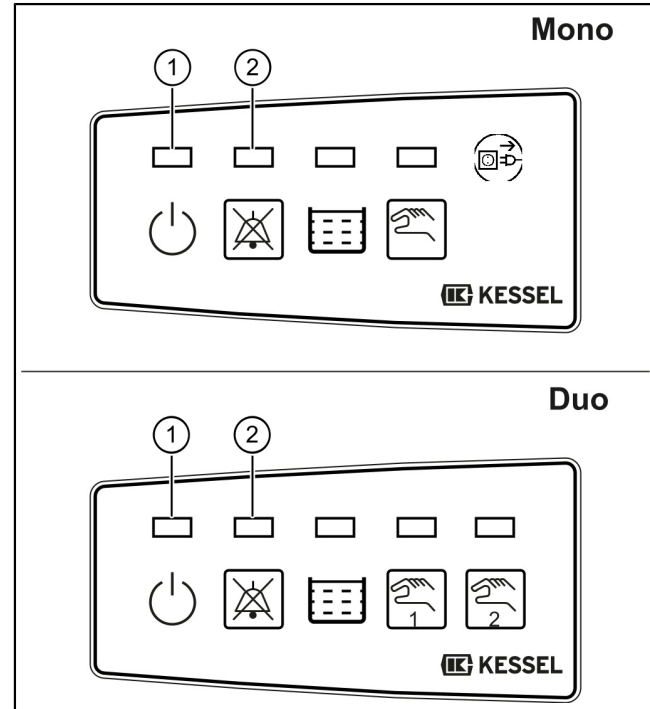

5.3 Funzionamento manuale

Il funzionamento manuale può essere attivato con il tasto (9) / (10). Successivamente non avverrà alcuna accensione automatica della pompa delle acque di scarico.

Se il funzionamento manuale viene acceso durante il pompaggio di svuotamento, la pompa delle acque di scarico si spegne.

Attivazione del funzionamento manuale

- ▶ Azionare il tasto (9) / (10), il LED di funzionamento manuale (4) / (5) lampeggia in arancio.

Con il funzionamento manuale attivato, la pompa delle acque di scarico può essere attivata come segue:

Accensione breve

- ▶ Premere il tasto (9) / (10) 1 volta.
- ✓ La pompa delle acque di scarico viene accesa per breve tempo.

Accensione prolungata



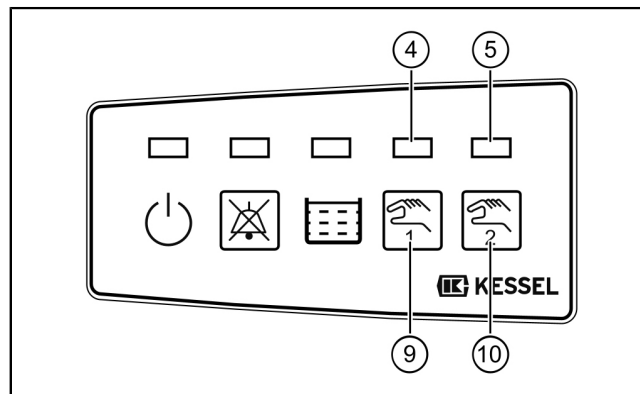

- ▶ Premere il tasto (9) / (10) e tenerlo premuto finché la pompa delle acque di scarico non si attiva.
- ✓ La pompa delle acque di scarico viene accesa.

ⓘ Se il funzionamento manuale non viene usato per > 5 minuti, la centralina attiva il funzionamento automatico.









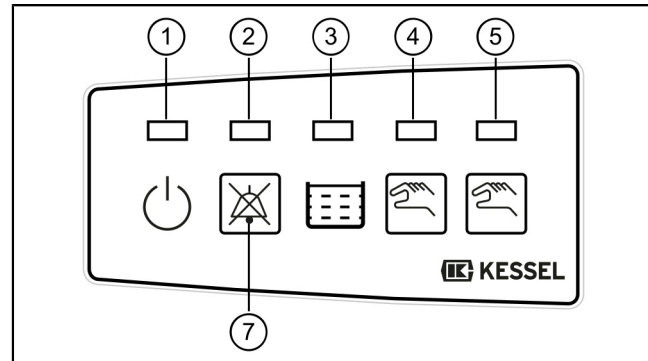











5.4 Visione d'insieme degli indicatori LED – Informazioni

Schema di lampeggio LED 1 – 5*

-  Lampeggiante
-  Illuminato / Acceso
-  Spento
-  Lampeggio alternato
-  Lampeggio contemporaneo
- 5* Solo con Aqualift L DUO



Stati di funzionamento





















LED				Segnale acustico (intervallo)	PFK ¹	Descrizione	Misura
 verde (1)	 Rosso (2)	 arancio (3)	 arancio (4) / (5*)				
				-	-	Fuori servizio, nessun monitoraggio della batteria ²	Ripristinare la tensione di rete elettrica
				-	-	Condizione di prontezza per il funzionamento	-
				-	-	Contenitore dell'impianto pieno, pompaggio di svuotamento entro breve tempo	Nessuna misura necessaria, la pompa delle acque di scarico può essere spenta con il tasto (8) (vd. "Funzionamento manuale", pagina 84)
				-	-	Il contenitore dell'impianto viene svuotato	

¹ Il contatto a potenziale zero viene attivato (il codice articolo 80074 deve essere stato prima collegato e attivato).









² Il monitoraggio batteria è attivo solo se al momento della messa in funzione è stata collegata una batteria.

5* Solo con Aqualift L DUO

Stati di allarme / Errori

LED				Segnale acustico (intervallo)	PFK ¹	Descrizione	Misura
verde (1)	Rosso (2)	arancio (3)	arancio (4) / (5*)				
				✓	Sì	Errore della batteria ²	Sostituire la batteria
				✓	Sì	Guasto alla rete elettrica, tensione di rete mancante, impianto non funzionante	Ripristinare la tensione di rete, confermare l'allarme
				✓	Sì	Errore di livello, è stata identificata una sequenza illogica del livello	Confermare l'allarme controllare l'entrata, controllare il blocco antiriflusso, errore di livello – controllare l'interruttore a galleggiante.
				✓	Sì	Numero/tempo massimo di funzionamento, la pompa delle acque di scarico è stata accesa troppo spesso o troppo a lungo	
				✓	Sì	Livello d'allarme superato	Attendere fino alla discesa sotto il livello d'allarme



LED				Segnale acustico (intervallo)	PFK ¹	Descrizione	Misura
 verde (1)	 Rosso (2)	 arancio (3)	 arancio (4) / (5*)				
				-	-	Cicli di commutazione massimi superati	Confermare l'allarme e sostituire la centralina

¹ Il contatto a potenziale zero viene attivato.

² Il monitoraggio batteria è attivo solo se al momento della messa in funzione è stata collegata una batteria.

5* Solo con Aqualift L DUO

Conferma dell'allarme

Il presentarsi di una condizione che genera un allarme è segnalato dall'accensione del LED d'allarme (2) ed eventualmente di uno degli altri LED. Dopo l'eliminazione della causa dell'allarme, l'allarme potrà essere confermato con la pressione del tasto (7).

Spegnimento del segnale acustico d'allarme

- Premere il tasto (7) 1 volta

Conferma dell'allarme

- Tenere premuto per >3 secondi il tasto (7).

✓ La visualizzazione d'allarme scompare, l'allarme è confermato.



5.5 Lettura dei dati e impostazione dei parametri

Con l'app KESSEL NFC e un dispositivo terminale abilitato alla NFC (ad esempio un telefono cellulare) è possibile leggere il diario d'esercizio della centralina, sincronizzare la data e l'ora e modificare diversi parametri.



AVVERTENZA

Prima dell'uso dell'app è necessario mettere in funzione la centralina vd. "capitolo Funzionamento", pagina 82.

Apple Store	Google Play Store
	
https://apps.apple.com/de/app/kessel-nfc/id6449256249	https://play.google.com/store/apps/details?id=com.kessel.nfcapp&gl=DE

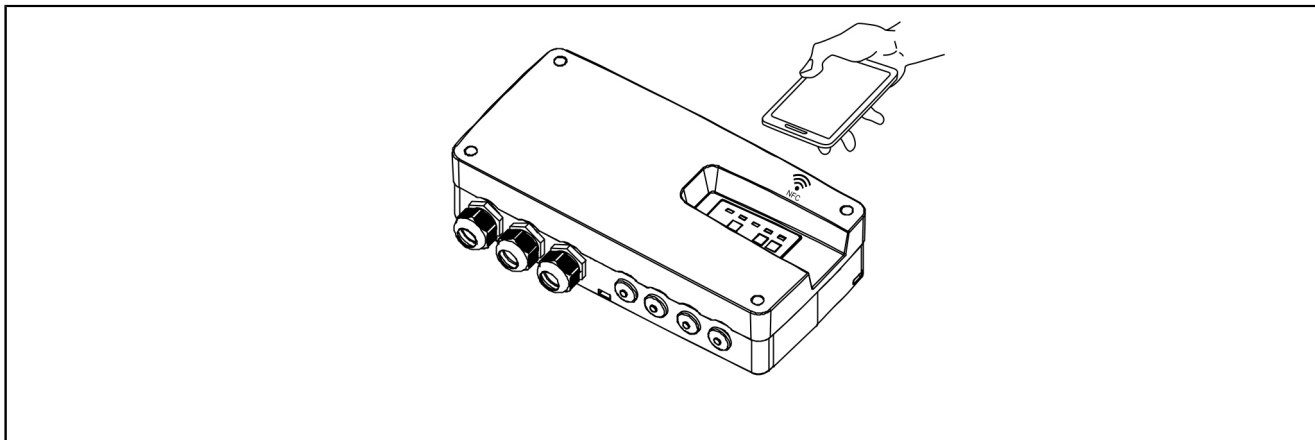

Fig.: Dispositivo terminale – smartphone

Lettura della centralina

Per questa operazione, il dispositivo terminale abilitato alla NFC deve trovarsi direttamente presso la centralina (*"figura Dispositivo terminale – smartphone"*).

Visualizzazione e modifica dei parametri:

Questi possono essere copiati e inviati via e-mail. (Password 1000)

5.6 Sincronizzazione di data/ora

Trasmissione dei dati dal dispositivo abilitato alla NFC alla centralina.

5.7 Spegnimento dell'impianto

- ▶ Disinserire l'impianto.
 - ▶ Premere il tasto (7) e tenerlo premuto fino a che il LED d'allarme (2) non lampeggia più, dopodiché la centralina si spegnerà automaticamente.
- ① Se la centralina è spenta, il collegamento alla batteria è disattivato. La batteria può rimanere connessa, in quanto non avviene alcuno scaricamento. Per l'inizializzazione è necessaria la tensione di rete, per fare in modo che il collegamento della batteria venga riattivato.

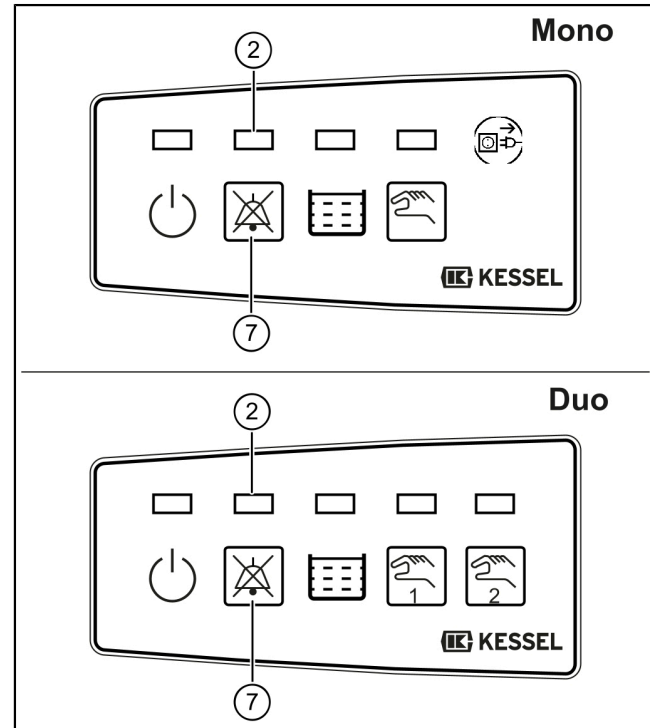

Inbouw- en bedieningshandleiding

Inhoud

1	Informatie over deze handleiding.....	93
2	Veiligheid.....	94
3	Technische gegevens.....	99
4	Monteren.....	100
5	Gebruik.....	104

Beste klant,

Als premium fabrikant van innovatieve producten voor de afwateringstechniek biedt KESSEL totale systeemoplossingen en klantgerichte service. Wij stellen hierbij maximale kwaliteitsnormen en zetten consequent in op duurzaamheid, niet alleen bij de productie van onze producten, maar ook met het oog op hun langdurige gebruik zetten wij ons in voor een permanente bescherming van u en uw eigendom.

KESSEL SE + Co. KG

Bahnhofstraße 31

D-85101 Lenting, Duitsland



Bij technische vragen helpen onze gekwalificeerde servicepartners u met alle plezier op locatie verder. U vindt uw contactpersoon op:

www.kessel-nederland.nl/servicepartners

www.kessel-belgie.be/servicepartners



Indien nodig ondersteunen onze servicepartners met diensten zoals inbedrijfstelling, onderhoud of algemene inspectie in de gehele DACH-regio, andere landen op aanvraag.



Informatie over afwikkeling en bestelling vindt u op:

www.kessel.de/service/dienstleistungen

1 Informatie over deze handleiding

Dit document bevat de originele bedieningshandleiding. De handleiding is in het Duits geschreven. Alle teksten in andere talen in deze handleiding zijn vertalingen van de oorspronkelijke Duitse tekst.

De handleiding wordt verduidelijkt met de volgende visuele conventies:

Afbeelding	Uitleg
[1]	zie afbeelding 1
[5]	Positienummer 5 van nevenstaande afbeelding
1 2 3 4 5 ...	Handeling op de afbeelding
 Controleren of de handmatige bediening is ingeschakeld.	Voorwaarde voor de handeling
 Op OK drukken.	Werkstap
 De installatie is bedrijfsklaar.	Resultaat van de handeling
zie "Veiligheid", pagina 94	Kruisverwijzing naar hoofdstuk 2
Vetgedrukt	Bijzonder belangrijke of voor de veiligheid relevante informatie
<i>Cursief schrift</i>	Variant of extra informatie (geldt bijv. alleen voor ATEX-variant)
	Technische instructies die in acht moeten worden genomen.

De volgende symbolen worden gebruikt:

Teken	Betekenis
	Schakel het apparaat vrij!
	Neem de gebruiksaanwijzing in acht
	CE-markering
	Waarschuwing elektriciteit
	AEEA-symbool, product is onderhevig aan de RoHS-richtlijn
 WAARSCHUWING	Waarschuwt tegen gevaar voor personen. Het niet opvolgen van deze aanwijzing kan ernstig letsel of de dood tot gevolg hebben.
 LET OP	Waarschuwt tegen gevaar voor personen en materiaal. Het niet opvolgen van deze aanwijzing kan ernstig letsel of materiële schade tot gevolg hebben.
	Waarschuwt voor explosiegevaarlijke atmosferen.

2 Veiligheid

2.1 Personeel/kwalificatie

Voor het gebruik van de installatie gelden de telkens geldige verordening inzake bedrijfsveiligheid en gevaarlijke stoffen of nationale verordeningen.

De exploitant van de installatie is verplicht tot:

- ▶ het maken van een risicobeoordeling,
- ▶ het vaststellen en aantonen van gevarenczones,
- ▶ het uitvoeren van veiligheidsinstructies,
- ▶ het beveiligen tegen gebruik door onbevoegden.

Persoon ¹⁾	Vrijgegeven werkzaamheden bij KESSEL-installaties		
Exploitant	Visuele controle, inspectie		
Deskundige (kent, begrijpt gebruiksaanwijzing)		Functiecontrole, configuratie van de besturingskast	
Elektriciens VDE 0105 (volgens voorschriften voor elektr. veiligheid of nationaal equivalent)			Werkzaamheden aan de elektrische installatie

1) Bediening en montage mogen alleen door personen van 18 jaar of ouder worden uitgevoerd.

2.2 Algemene veiligheidsinstructies



LET OP **Installatie vrijgeschakelen!**



- ▶ Zorgen dat de elektrische onderdelen tijdens de werkzaamheden van de voedingsspanning zijn losgekoppeld.
- ▶ Zorg dat elektrische apparaten niet opnieuw kunnen worden ingeschakeld.



WAARSCHUWING

Spanningvoerende onderdelen! De behuizing van de besturingskast mag uitsluitend door een gediplomeerd elektricien worden geopend!

De activiteiten bij de besturingskast zijn tot:

- ▶ het inschakelen van de veiligheidsschakelaar en het aanpassen van de motorbeveiligingsschakelaar,
- ▶ het vervangen van de batterijen,
- ▶ het aansluiten volgens de inbouwhandleiding en het aansluitschema beperkt.

Alle verdergaande werkzaamheden mogen enkel door de KESSEL-klantenservice of een servicepartner van KESSEL SE + Co. KG worden uitgevoerd.



WAARSCHUWING

Spanningvoerende delen

Bij werkzaamheden aan de elektrische bekabeling en aansluitingen het onderstaande in acht nemen.

- ▶ Voor alle aansluitingen en installatiewerkzaamheden aan de installatie gelden nationale voorschriften voor elektrische veiligheid.
- ▶ De installatie moet via een lekstroomvoorziening (RCD) met een nominale lekstroom van niet meer dan 30 mA worden gevoed.



Gebruiks- en onderhoudshandleidingen moeten bij product beschikbaar gehouden worden.



LET OP

Onjuiste reiniging

Kunststof onderdelen kunnen beschadigd raken of broos worden

- ▶ Reinig kunststof onderdelen alleen met water en een pH-neutraal reinigingsmiddel.

2.3 Reglementair gebruik

De besturingskast vormt de besturing van een opvoerinstallatie of pompstation voor afvalwater. Voor de niveaudetectie worden vlotterschakelaars gebruikt. Als het schakelniveau is bereikt, wordt het wegpompen geactiveerd. Als het peil navenant is gedaald, wordt het wegpompen automatisch beëindigd.

Afhankelijk van de variant is de besturingskast bedoeld voor één (mono) of twee (duo) pompen.



WAARSCHUWING

De besturingskast zelf is NIET bedoeld voor inbouw in een EX-zone!

De besturingskast bevat een passende elektrische voorziening voor een intrinsiek veilig circuit.

Alle niet expliciet en schriftelijk door de fabrikant toegestane:

- afwijkingen van de technische specificaties
- om- of aanbouw
- gebruik van niet-originele onderdelen
- reparaties door niet door de fabrikant geautoriseerde bedrijven en personen

kunnen leiden tot het verlies van de fabrieksgarantie.

Advies voor het plaatsen van buitenkasten





WAARSCHUWING

Overschrijding van de maximaal toelaatbare bedrijfstemperatuur

Mogelijke storing van de besturingskast

- ▶ Houd rekening met de installatielocatie van de buitenkast.
- ▶ De invloed van zonlicht op de opstellocatie schatten.
- ▶ Houd rekening met de plaatselijke omgevingsomstandigheden.

In de volgende tabel vindt u een overzicht van de vereiste maatregelen:

	<p>Verwachting van regelmatig fel zonlicht van acht of meer uur en/of aanvoer van verwarmde omgevingslucht</p>	<p>De montage van een koelvoorziening voor buitenkasten (art.nr. 681148) is vereist.</p>
	<p>Onregelmatig, tijdelijk hogere hoeveelheid zonlicht te verwachten</p>	<p>Monteer een commercieel verkrijgbare ventilator met temperatuursensor voor het ventileren van de binnenkant. De ventilatie moet worden ingeschakeld vanaf een temperatuur van 40 °C in de buitenkast.</p>
	<p>De opstellocatie ligt doorgaans in de schaduw en/of in de omgeving zijn er weinig temperatuurschommelingen</p>	<p>Geen maatregelen vereist.</p>

2.3.1 Module- en functieoverzicht

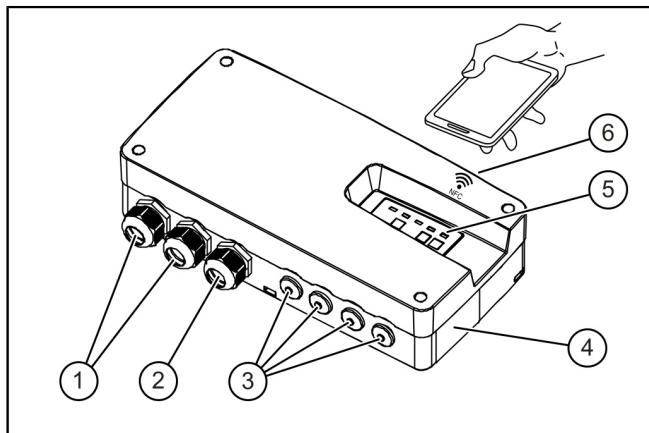

(1)	Aansluitingen voor pomp(en)
(2)	Netaansluitkabel
(3)	Blindstoppen, optionele aansluitingen
(4)	Typeplaatje
(5)	Leds voor bediening
(6)	NFC

2.3.2 Indicaties, besturingstoetsen en hun functies

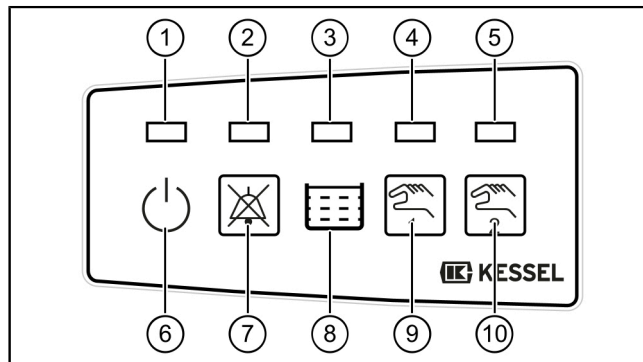

(1)	Bedrijfsklaar (groene led)
(2)	Alarm (rode led)
(3)	Inschakelniveau bereikt (oranje led)
(4)	Afvalwaterpomp draait (oranje led)
(5)	Afvalwaterpomp draait (oranje led, alleen Duo)
(6)	Symbol in bedrijf
(7)	Toets alarm uitschakelen (resetten)
(8)	Symbol reservoir
(9)	Toets afvalwaterpomp aan (handmatig)
(10)	Toets afvalwaterpomp aan (handmatig, alleen Duo)

3 Technische gegevens

Opgave	Mono	Duo
Maximaal vermogen bij uitgang schakelaar (bij $\cos. \varphi = 1$)	4 kW	2 x 4 kW
Nominaal stroombereik	2,5 – 6 A	2,5 – 6 A*
Gewicht	1 kg	1,3 kg
Afmetingen (lxbxd)	234x184x75 mm	305x184x75 mm
Bedrijfsspanning	400 V / 50 Hz	
Vermogen, stand-by	2 W	
Potentiaalvrij contact	max. 42 V DC / 0,5 A	
Specificaties batterij	9 V 6LR61	
Gebruikstemperatuur	0 – 50 °C	
Relatieve luchtvochtigheid [%] (niet-condenserend)	max. 90 %	
Beschermingsklasse	IP 54	
Beschermingsklasse	I	
Vereiste zekering, A, (Mono)	C16	C16 (C20**)
RCD	30 mA	

Titel

* Duo-installaties beschikken over twee pompen met identieke technische gegevens.

** als de nominale stroom van beide pompen samen meer dan 5 A bedraagt

4 Monteren

4.1 Besturingskast monteren

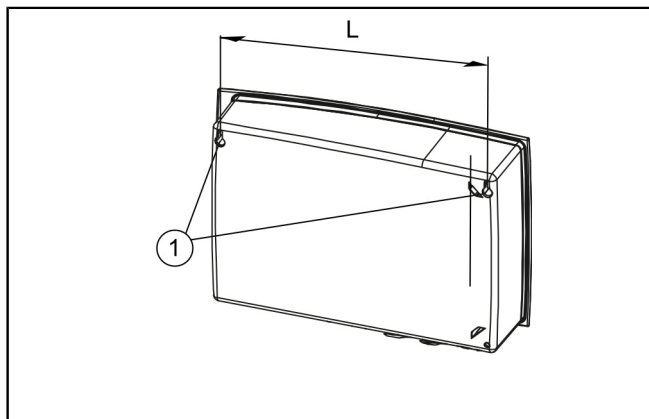

(L)	Mono: sleutelgaten hart-op-hart 208 mm Duo: sleutelgaten hart-op-hart 277 mm
-----	---

- ▶ Kies een montageplek en zorg daarbij dat:
 - In de directe omgeving van de besturingskast een passende stroomvoorziening aanwezig is.
 - De besturingskast op een toegankelijke plek en voldoende stevig wordt bevestigd.

- ▶ Monteer alle bevestigingsschroeven. Zorg hierbij dat de afstand tussen de schroefkoppen en het bevestigingsvlak ongeveer 3 tot 4 mm bedraagt.
- ▶ Hang de besturingskast aan de bevestigingsschroeven en duw hem licht omlaag.
- ⓘ De besturingskast is alleen bedoeld voor montage binnenshuis of in een KESSEL-buitenkast.
Hij mag niet worden blootgesteld aan direct zonlicht en moet in een droge, goed geventileerde en vorstvrije omgeving worden geïnstalleerd.

4.2 Aansluitschema

Gebruik het aansluitschema dat bij het specifieke product hoort.

Aansluitschema mono 400 V: Aquapump Small Mono en Aqualift L Mono	zie "Aansluitschema (mono) ", pagina 137
Aansluitschema duo 400 V: Aquapump Small Duo	zie "Aansluitschema (duo)", pagina 138
Aansluitschema duo 400 V: Aqualift L Duo	zie "Aansluitschema duo Aqualift L", pagina 139

4.3 Elektrische aansluiting



GEVAAR

Gevaar door foutief gedimensioneerd leidingwerk.

De installatie is uitsluitend voor gebruik met de meegeleverde (of gelijkwaardige) aansluitleidingen bedoeld. In geval van twijfel met de fabrikant/leverancier overleggen.



- Leg de aansluitkabels correct van het reservoir naar de besturingskast (bijv. met een mantelbuis). Zorg dat er voldoende kabel lengte is voor het onderhoud aan elektrische onderdelen.
- ▶ Breng op de kabeluiteinden adereindhulzen (lengte 8 mm) aan.
- ▶ Schroef het deksel van de behuizing los en verwijder het.

Mono/Duo: vier schroeven in de hoeken van de behuizingsafdekking

- ▶ Voer de aansluitkabel door de kabeldoorvoer. Hiervoor moet u mogelijk de breekpunten van de benodigde kabeldoorvoeren openen. ❶



LET OP
Let op IP54

- ▶ Breek de kabeldoorvoeren met geschikt gereedschap open. ❷
- ▶ Druk de rubberen kabeldoorvoeren in de openingen. ❸
- ▶ Snijd de verdikkingen van de gebruikte kabeldoorvoeren af. ❹
- ▶ Bevestig de aansluitkabels conform het aansluitschema op de klemstrip.
Hiervoor drukt u de kabelklem tegen de veerdruk in met een geschikte schroevendraaier omlaag tot het uiteinde van de kabel in de klem is gestoken. ❺

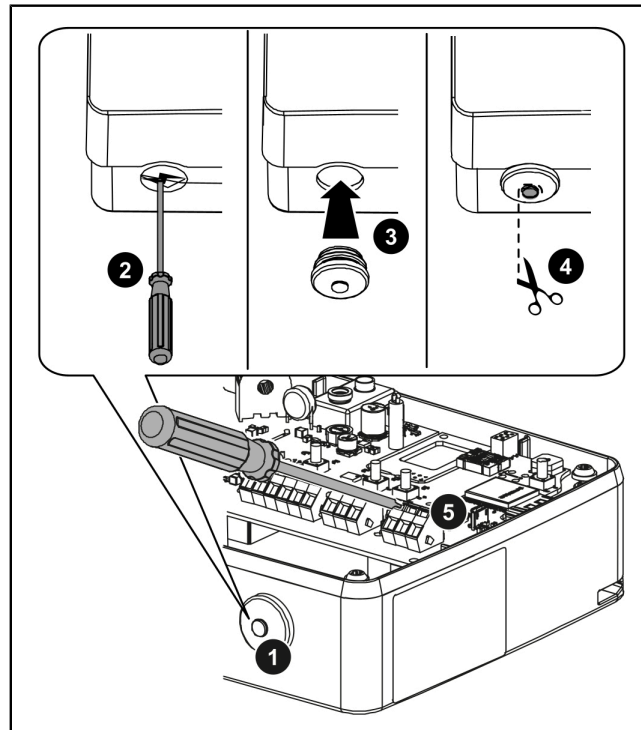

- ▶ Leg de aansluitkabels correct van het reservoir naar de besturingskast (bijv. met een mantelbuis). Zorg dat er voldoende kabellengte is voor het onderhoud aan elektrische onderdelen.
- ▶ Sluit de accustekker aan op de accu. **6**
- ▶ Kabel van de accu zo leggen dat de leds niet worden bedekt of ingeklemd.
- ▶ Breng voor alle aansluitkabels trekontlastingen aan (aanhaalmoment 0,5 Nm). **7**
- ▶ Het deksel van de behuizing aanbrengen en bevestigen, aanhaalmoment 1,2 Nm.

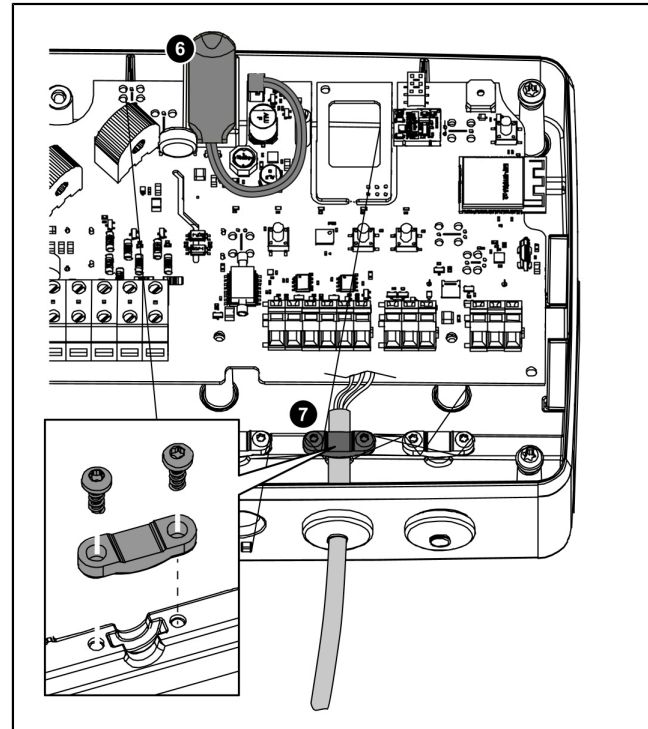

5 Gebruik

5.1 Automatische modus

De installatie staat in de automatische modus als er geen storing wordt herkend en de bedrijfsled (1) groen brandt. De afvalwaterpomp wordt al naargelang het vuilwaterpeil in- en uitgeschakeld.

Bij de besturingskasten 400 V mono/duo is het mogelijk om met de KESSEL-NFC-app en een apparaat met NFC-ondersteuning (bijv. een mobiele telefoon) het logboek van de besturingskast uit te lezen, de datum en tijd te synchroniseren en verschillende parameters aan te passen.

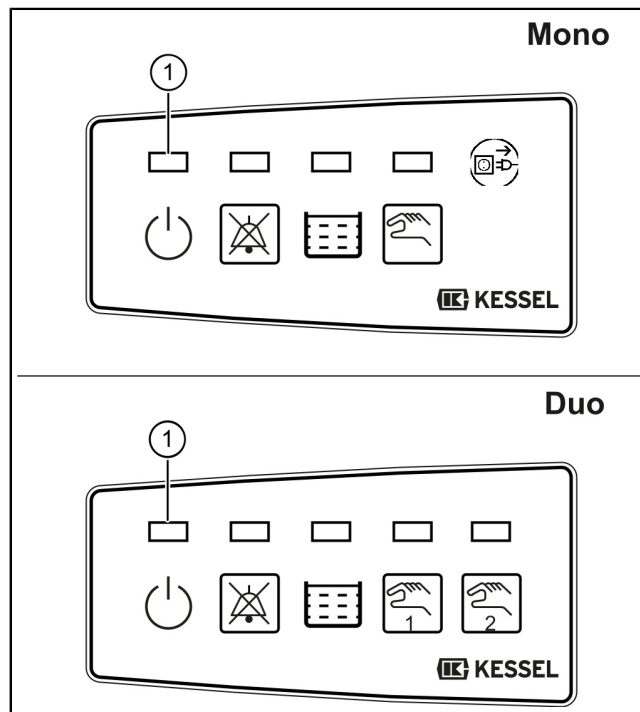

5.2 Alarmtoestanden

Alarm reservoir te vol

- Als het peil in het reservoir het alarmniveau overschrijdt (vlotterschakelaar) wordt het alarm geactiveerd, knippert de alarmled (2) en klinkt er een waarschuwingssignaal. De afvalwaterpomp draait.
- Deze alarmtoestand kan niet worden opgeheven, deze verdwijnt pas nadat het reservoir met succes is leeggepompt. De akoestische waarschuwing kan wel worden uitgeschakeld (kort op de alarmtoets drukken).

Alarm stroomuitval

- Als de stroom uitvalt, gaat de groene bedrijfsled (1) na een seconde uit, knippert de alarmled (2) en klinkt er herhaaldelijk een waarschuwingssignaal. De afvalwaterpomp kan niet meer worden ingeschakeld.
- Zodra de voedingsspanning weer terugkeert, wordt de alarmtoestand niet meer weergegeven op de bestuurskast en werkt de installatie weer in de automatische modus.

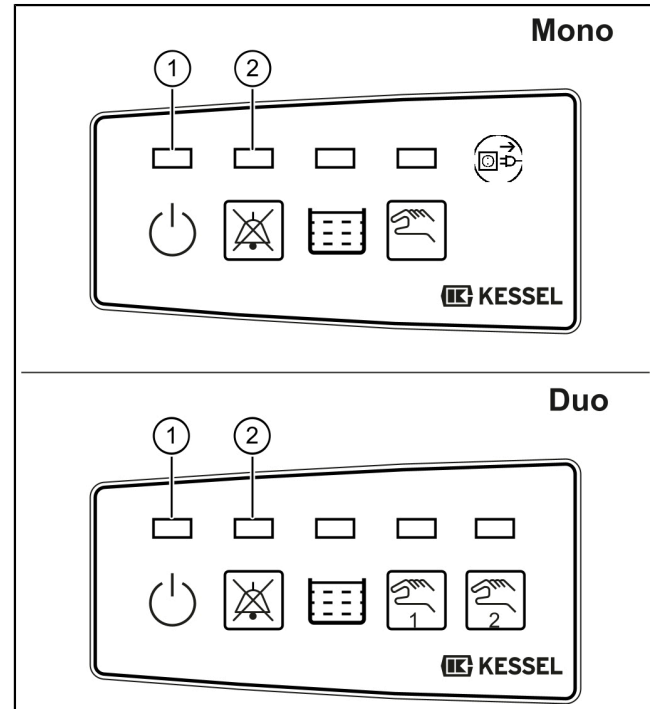

5.3 Handbediening

De handbediening kan met de toets (9) / (10) worden geactiveerd. In dat geval vindt geen automatische inschakeling van de afvalwaterpomp meer plaats.

Wordt handbediening tijdens afpompen ingeschakeld, schakelt de afvalwaterpomp uit.

Handbediening activeren

- ▶ Druk op toets (9) / (10); de led voor handbediening (4) / (5) knippert oranje.

Bij geactiveerde handbediening kan de afvalwaterpomp als volgt worden ingeschakeld:

Kortstondig inschakelen

- ▶ Toets (9) / (10) één keer indrukken.
- ✓ De afvalwaterpomp wordt even kort ingeschakeld.

Langer inschakelen

- ▶ Houd toets (9) / (10) net zo lang ingedrukt als de afvalwaterpomp ingeschakeld moet blijven.
- ✓ De afvalwaterpomp wordt ingeschakeld.

① Als de handmatige bediening > 5 min niet wordt gebruikt, activeert de besturingskast de automatische bediening.

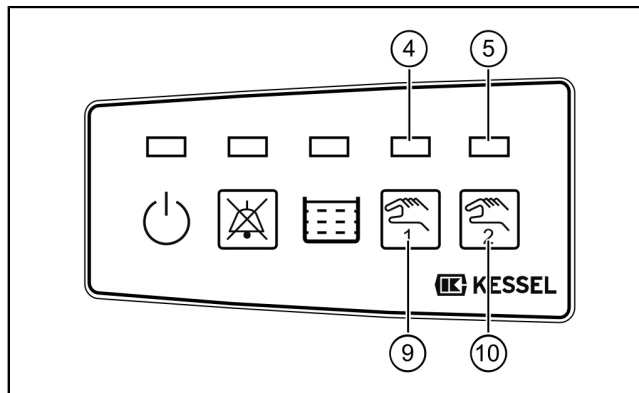



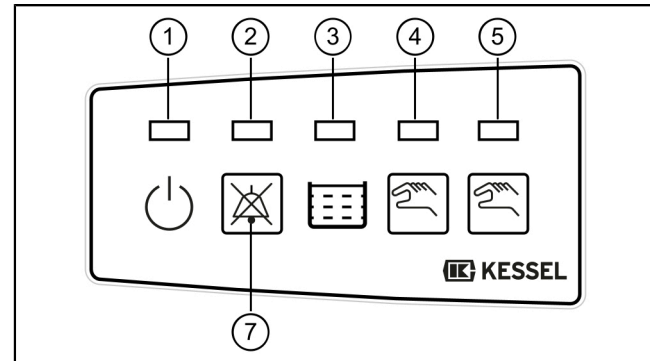

5.4 Overzicht van ledaanduidingen/informatie

Knipperpatroon leds 1 – 5*

-  Knipperen
-  Branden/ingeschakeld
-  Uitgeschakeld
-  Afwisselend knipperen
-  Gelijktijdig knipperen
- 5* Alleen bij Aqualift L Duo



Bedrijfstoestanden

Led				Waarschuwings-sig-naal (interval)	PFK ¹	Omschrijving	Maatregel
groen (1)	rood (2)	oranje (3)	oranje (4) / (5*)				
				-	-	Buiten bedrijf, geen batterijbewaking ²	Netspanning herstellen





















Led				Waarschuwings-sig-naal (interval)	PFK ¹	Omschrijving	Maatregel
 groen (1)	 rood (2)	 oranje (3)	 oranje (4) / (5*)				
●	○	○	○	-	-	Bedrijfsklaar	-
●	○	●	◐	-	-	Reservoir vol, deze wordt binnenkort leeggepompt	Geen maatregelen nodig, de afvalwaterpomp kan met de toets (8) worden uitgeschakeld (zie "Handbediening", pagina 106)
●	○	●	●	-	-	Reservoir wordt leeggepompt	

¹ Het potentiaalvrij contact wordt geactiveerd (art.nr. 80074 moet eerst zijn geactiveerd en aangesloten).

² De accubewaking is alleen actief als tijdens de inbedrijfstelling een accu was aangesloten.

5* Alleen bij Aqualift L Duo

Alarmtoestanden/storing

Led				Waarschuwings-sig-naal (interval)	PFK ¹	Omschrijving	Maatregel
groen (1)	rood (2)	oranje (3)	oranje (4) / (5*)				
				✓	Ja	Batterijfout ²	Batterij vervangen
				✓	Ja	Stroomstoring, net-spanning ontbreekt, installatie buiten dienst	Netspanning herstellen, alarm resetten
				✓	Ja	Niveaustoring, onlogische volgorde van niveaus herkend	Bevestig het alarm en controleer de toevoer en de terugslagklep. Niveaufout: controleer de vlotterschakelaar.
				✓	Ja	Grensloupaantal/-tijd, afvalwaterpomp werd te vaak of te lang ingeschakeld	
				✓	Ja	Alarmniveau overschreden	Wachten tot het alarmniveau weer tot onder de schakelwaarde is gedaald



Led				Waarschuwings-sig-naal (interval)	PFK ¹	Omschrijving	Maatregel
groen (1)	rood (2)	oranje (3)	oranje (4) / (5*)				
				-	-	Maximale aantal schakelcycli overschreden	Alarm resetten en bestu-ringskast vervangen

¹ Het potentiaalvrij contact wordt geactiveerd.

² De accubewaking is alleen actief als tijdens de inbedrijfstelling een accu was aangesloten.

5* Alleen bij Aqualift L Duo

Alarm bevestigen

Als er een storing optreedt, is dat zichtbaar aan alarmled (2) evt. i.c.m. andere leds. Na het opheffen van de oorzaak voor het alarm kan het alarm worden gereset door het indrukken van toets (7).

Alarmtoon uitschakelen

- ▶ Toets (7) 1 x indrukken

Alarm resetten

- ▶ Toets (7) 3 seconden lang ingedrukt houden.
- ✓ De alarmweergave gaat uit, het alarm is gereset.



5.5 Gegevens uitlezen en parameters instellen

Met de KESSEL NFC-app en een apparaat met NFC-ondersteuning (bijv. een mobiele telefoon) kan het logboek van de besturingskast worden uitgelezen, kunnen datum en tijd worden gesynchroniseerd en kunnen verschillende parameters worden aangepast.



WAARSCHUWING

Om de app te kunnen gebruiken, moet de besturingskast in bedrijf worden gesteld zie *"Hoofstuk Bedrijf"*, pagina 104.

Apple Store	Google Play Store
	
https://apps.apple.com/de/app/kessel-nfc/id64449256249	https://play.google.com/store/apps/details?id=com.kessel.nfcapp&gl=DE



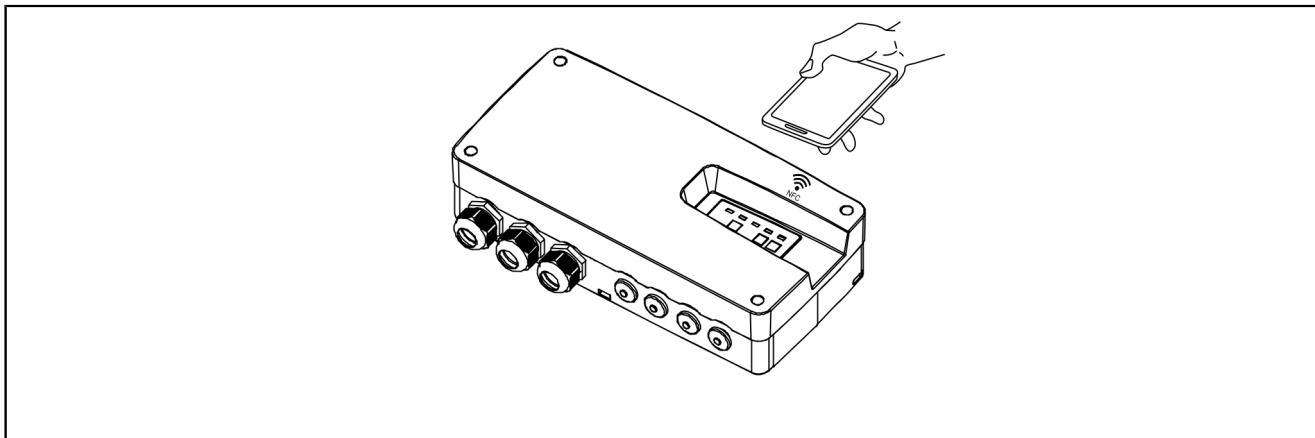

Afb.: Eindapparaat: smartphone

Besturingskast uitlezen

Hiervoor moet het eindapparaat met NFC-ondersteuning vlakbij de besturingskast worden gehouden ("*afb. eindapparaat-smartphone*").

Parameters bekijken en aanpassen:

De parameters kunnen worden gekopieerd en per e-mail worden verzonden. (Wachtwoord 1000)

5.6 Datum/tijd synchroniseren

Waarden van het apparaat met NFC-ondersteuning naar de besturingskast overbrengen.

5.7 Installatie uitschakelen

- ▶ Installatie loskoppelen.
 - ▶ Houd de toets alarm (7) net zo lang ingedrukt tot de alarmled (2) niet meer knippert; de besturingskast schakelt zichzelf nu uit.
- ① Als de besturingskast is uitgeschakeld, is de batterijaansluiting niet geactiveerd. De batterij kan gewoon blijven zitten, omdat er geen ontlading plaatsvindt. Voor de initialisatie is netspanning nodig, zodat daarmee ook de batterij weer wordt geactiveerd.

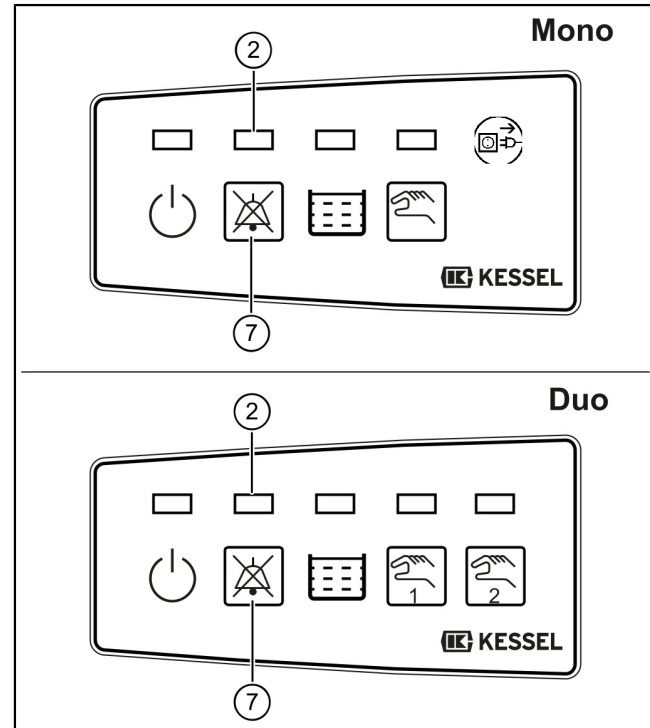

Instrukcja zabudowy i obsługi

Spis treści

1	Wskazówki dotyczące niniejszej instrukcji.....	115
2	Bezpieczeństwo.....	116
3	Dane techniczne.....	122
4	Montaż.....	123
5	Eksploatacja.....	127

Szanowna Klientko, Szanowny Kliencie,

jako producent najwyższej klasy innowacyjnych produktów z zakresu techniki odwadniania firma KESSEL oferuje kompleksowe rozwiązania systemowe i serwis odpowiadający potrzebom klientów. Stawiamy sobie najwyższe standardy jakościowe i konsekwentnie stawiamy na trwałość – nie tylko podczas produkcji naszych urządzeń, lecz również w zakresie ich długotrwałego użytkowania dbamy o to, by stale gwarantowane było bezpieczeństwo użytkownika i jego mienia.

Kessel Sp. z o.o.

Innowacyjna 2, Biskupice Podgórne

55-040 Kobierzyce



W razie pytań natury technicznej proszę zwrócić się do naszych fachowych partnerów serwisowych w Państwa okolicy.

Osobę kontaktową znajdą Państwo tutaj:

<http://www.kessel.pl/kontakt0/biuro/doradztwo-techniczne.html>



W razie potrzeby nasz autoryzowany serwis oferuje Państwu usługi w zakresie uruchomienia, konserwacji i przeglądu generalnego na całym terenie Polski, w innych krajach na żądanie.



Informacje na temat realizacji i zamówienia patrz tutaj:

www.kessel.de/service/dienstleistungen

1 Wskazówki dotyczące niniejszej instrukcji

Niniejszy dokument jest oryginalną instrukcją obsługi. Oryginalna instrukcja obsługi jest napisana w języku niemieckim. Wszystkie inne wersje językowe tej instrukcji są tłumaczeniem oryginalnej instrukcji obsługi.

Poniższe formy oznaczeń ułatwiają orientację:

Oznaczenie	Objaśnienie
[1]	patrz rysunek 1
(5)	Numer pozycji 5 na rysunku obok
1 2 3 4 5 ...	Krok postępowania na rysunku
 Sprawdzić, czy aktywowana została obsługa ręczna.	Warunek postępowania
 Nacisnąć przycisk OK.	Krok postępowania
 Urządzenie jest gotowe do pracy.	Wynik postępowania
<i>patrz "Bezpieczeństwo", strona 116</i>	Odniesienie do rozdz. 2
Czcionka pogrubiona	Informacja szczególnie ważna lub istotna dla bezpieczeństwa
<i>Kursywa</i>	Wariant lub informacja dodatkowa (np. obowiązuje tylko dla wariantu ATEX)

Oznaczenie	Objaśnienie
	Wskazówki techniczne, których należy szczególnie przestrzegać.

Używane są następujące symbole:

Symbol	Znaczenie
	Odłączyć urządzenie od prądu!
	Przestrzegać instrukcji obsługi
	Znak CE
	Ostrzeżenie przed prądem elektrycznym
	Symbol WEEE, produkt podlega dyrektywie RoHS
 OSTRZEŻENIE	Ostrzeżenie przed zagrożeniem dla osób. Nieprzestrzeganie tej wskazówki może prowadzić do najcięższych obrażeń ciała lub śmierci.
 OSTROŻNIE	Ostrzeżenie przed zagrożeniem dla osób lub rzeczy. Nieprzestrzeganie tej wskazówki może prowadzić do ciężkich obrażeń ciała lub szkód materialnych.

Symbol	Znaczenie
	Ostrzeżenie przed atmosferą wybuchową.

2 Bezpieczeństwo

2.1 Kwalifikacje personelu

Podczas eksploatacji urządzenia obowiązują odpowiednie rozporządzenie w sprawie bezpieczeństwa pracy (niem. Betriebssicherheitsverordnung) i rozporządzenie o materiałach niebezpiecznych (niem. Gefahrstoffverordnung) lub ich krajowe odpowiedniki.

Użytkownik urządzenia jest zobowiązany do:

- ▶ sporządzenia oceny zagrożenia,
- ▶ wyznaczenia i oznakowania odpowiednich stref zagrożenia,
- ▶ przeprowadzenia instruktaży postępowania w razie niebezpieczeństwa,
- ▶ zabezpieczenia przed użyciem przez osoby nieupoważnione.

Osoba ¹⁾	Dozwolone czynności przy urządzeniach KESSEL		
Użytkownik	Oględziny, przegląd		
Osoba o odpowiednich kwalifikacjach, (zna i rozumie instrukcję obsługi)		Kontrola działania, konfiguracja urządzenia sterującego	
Wykwalifikowany elektryk wg VDE 0105 (zgodnie z przepisami bezpieczeństwa elektrycznego lub ich krajowymi odpowiednikami)			Prace przy instalacji elektrycznej

1) Obsługi i montażu mogą dokonywać wyłącznie osoby, które ukończyły 18 rok życia.

2.2 Ogólne zasady bezpieczeństwa



UWAGA

Odłączyć urządzenie od zasilania!

- ▶ Zapewnić, aby urządzenia elektryczne były na czas prac odłączone od zasilania napięciem.
- ▶ Zabezpieczyć urządzenia elektryczne przed ponownym włączeniem.



OSTRZEŻENIE

Elementy będące pod napięciem! Obudowę urządzenia sterującego może otwierać wyłącznie elektryk!

Prace przy urządzeniu sterującym ograniczają się do:

- ▶ włączenia stycznika i dopasowania stycznika silnikowego,
- ▶ wymiany baterii,
- ▶ podłączenia według instrukcji zabudowy i schematu połączeń.

Wszystkie inne, wykraczające poza to prace, wolno wykonywać wyłącznie serwisowi klienta firmy KESSEL lub partnerowi serwisowemu firmy KESSEL SE + Co. KG.



OSTRZEŻENIE

Elementy będące pod napięciem

Podczas prac przy przewodach i przyłączach elektrycznych należy przestrzegać następujących wskázówek.

- ▶ Do wszystkich prac związanych z podłączeniem i instalacją na urządzeniu mają zastosowanie przepisy krajowe dot. bezpieczeństwa elektrycznego.
- ▶ Urządzenie musi posiadać wyłącznik różnicowoprądowy (RCD) o prądzie zadziałania nie większym niż 30 mA.



Instrukcje obsługi i konserwacji muszą się znajdować w pobliżu produktu i być dostępne.



UWAGA

Niewłaściwe czyszczenie

Plastikowe elementy mogą ulec uszkodzeniu lub pękać

- ▶ Elementy plastikowe należy czyścić wyłącznie wodą i środkiem czyszczącym o neutralnym pH.

2.3 Zastosowanie zgodnie z przeznaczeniem

Sterownik przeznaczony jest do sterowania przepompownią ścieków. Do rozpoznawania poziomu służy pływak. Gdy osiągnięty zostanie poziom przełączenia, rozpoczęte zostaje pompowanie. Gdy poziom ścieków odpowiednio spadnie, pompowanie zostaje samoczynnie zakończone.

Zależnie od wariantu sterownik jest przeznaczony do jednej (Mono) lub dwóch (Duo) pomp.



OSTRZEŻENIE

Sterownik NIE jest przewidziany do zabudowy w strefie zagrożonej wybuchem!

Sterownik posiada wyposażenie elektryczne do obwodów iskrobezpiecznych.

Wszystkie nieautoryzowane przez producenta wyraźnie i pisemnie:

- odchylenia od specyfikacji technicznych
 - przebudowy lub dobudowy
 - użycie nieoryginalnych części zamiennych
 - naprawy wykonane przez zakłady lub osoby nieautoryzowane przez producenta
- mogą prowadzić do utraty gwarancji.

Uwagi dotyczące pozycjonowania szafek sterowniczych zewnętrznych





OSTRZEŻENIE

Przekroczenie maksymalnej dopuszczalnej temperatury roboczej

Możliwa usterka sterownika

- ▶ Uwzględnić miejsce ustawienia szafki sterowniczej zewnętrznej.
- ▶ Ocenić nasłonecznienie w miejscu ustawienia.
- ▶ Uwzględnić lokalne warunki otoczenia.

Poniższa tabela zawiera przegląd odpowiednich środków:

	<p>Należy liczyć się z regularnym, mocnym nasłonecznieniem przez 8 godzin lub dłużej i/lub gromadzeniem się ogrzanego powietrza</p>	<p>Konieczny jest montaż zestawu urządzeń chłodzących do szafek sterowniczych zewnętrznych (nr art. 681148).</p>
	<p>Należy liczyć się z nieregularnym, częściowo intensywniejszym nasłonecznieniem.</p>	<p>Zainstalować dostępny w sklepach wentylator z funkcją rozpoznawania temperatury do wentylacji wnętrza. Wentylacja powinna załączać się, gdy temperatura wewnątrz szafy sterowniczej osiągnie 40°C.</p>
	<p>Zacienione miejsce ustawienia i/lub warunki otoczenia z nieznacznymi wahaniami temperatury</p>	<p>Nie jest konieczne podjęcie żadnych środków.</p>

2.3.1 Przegląd podzespołów i funkcji

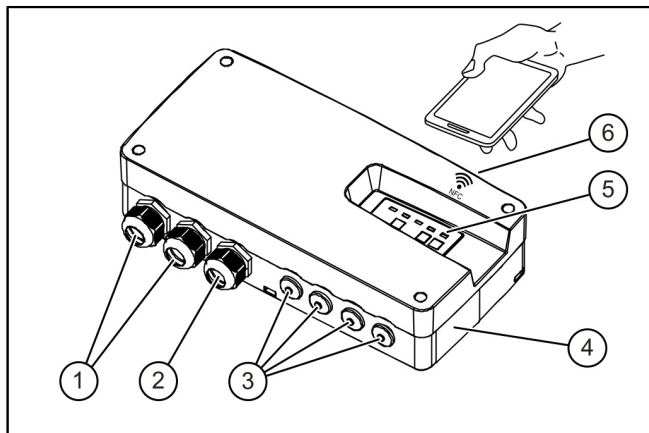

(1)	Przyłącza pomp(y)
(2)	Przewód sieciowy
(3)	Zaślepka, opcjonalne przyłącza
(4)	Tabliczka znamionowa
(5)	Diody LED i panel sterowania
(6)	NFC

2.3.2 Wskazania, przyciski do obsługi i ich funkcje

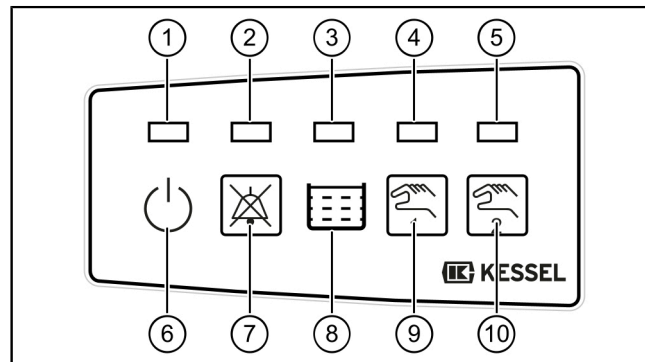

(1)	Dioda LED gotowości do pracy (zielona)
(2)	Dioda LED alarmu (czerwona)
(3)	Dioda LED „osiągnięto poziom załączenia” (pomarańczowa)
(4)	Dioda LED „pompa do ścieków pracuje” (pomarańczowa)
(5)	Dioda LED „pompa do ścieków pracuje” (pomarańczowa), (tylko Duo)
(6)	Symbol pracy
(7)	Przycisk do wyłączenia (skasowania) alarmu
(8)	Symbol zbiornika urządzenia
(9)	Przycisk do włączenia pompy do ścieków (ręcznie)
(10)	Przycisk do włączenia pompy do ścieków (ręcznie), (tylko Duo)

3 Dane techniczne

Dane	Mono	Duo
Maksymalna moc na wyjściu przełączającym (dla $\cos \varphi = 1$)	4 kW	2 x 4 kW
Zakres prądu znamionowego	2,5 - 6 A	2,5 - 6 A*
Ciężar	1 kg	1,3 kg
Wymiary (dł x szer x gł)	234x184x75 mm	305x184x75 mm
Napięcie robocze	400 V / 50 Hz	
Moc w stanie czuwania	2 W	
Kontakt bezpotencjałowy	maks. 42 V DC / 0,5 A	
Specyfikacja baterii	9 V 6LR61	
Temperatura użytkowania	0 - 50 °C	
Względna wilgotność powietrza [%] (bez kondensacji)	maks. 90 %	
Stopień ochrony	IP 54	
Klasa ochrony	I	
Wymagany bezpiecznik, A (Mono)	C16	C16 (C20**)
RCD	30 mA	

* Urządzenia typu Duo posiadają dwie pompy o identycznych danych technicznych.

** w pompach o wyznaczonym zakresie prądu znamionowego powyżej 5 A (łącznie)

4 Montaż

4.1 Montaż urządzenia sterującego

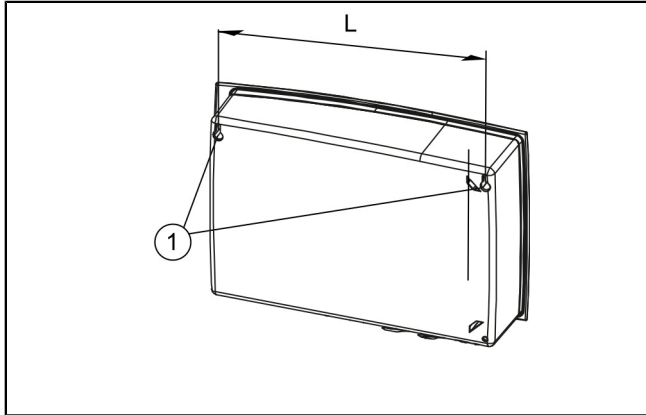

(L)	Mono: środek-środek otwór na klucz 208 mm Duo: środek-środek otwór na klucz 277 mm
-----	---

- ▶ Wybrać położenie montażowe, zwracając uwagę na następujące kwestie:
 - Pasujące zasilanie energią elektryczną znajduje się w bezpośrednim pobliżu urządzenia sterującego.
 - Sterownik musi być przymocowany w bezpieczny i wystarczająco mocny sposób w dostępnym miejscu.

- ▶ Zamontować wszystkie śruby mocujące. Upewnić się przy tym, że odległość pomiędzy łbami śrub a powierzchnią montażową wynosi ok. 3 do 4 mm.
- ▶ Zawiesić urządzenie sterujące na śrubach mocujących i lekko wcisnąć je w dół.
- ⓘ Sterownik jest przeznaczony wyłącznie do montażu wewnątrz budynku lub w zewnętrznej szafce sterowniczej firmy KESSEL.
Nie wolno wystawiać go na bezpośrednie działanie promieni słonecznych i należy go zamontować w suchym, dobrze wentylowanym i niezamarzającym miejscu.

4.2 Schemat połączeń

W zależności od produktu należy stosować odpowiedni schemat połączeń.

Schemat połączeń Mono 400V: Aquapump Small Mono oraz Aqualift L Mono	<i>patrz "Schemat połączeń Mono ", strona 137</i>
Schemat połączeń Duo 400V: Aquapump Small Duo	<i>patrz "Schemat połączeń Duo", strona 138</i>
Schemat połączeń Duo 400V: Aqualift L Duo	<i>patrz "Schemat połączeń Duo Aqualift L", strona 139</i>

4.3 Przyłącze elektryczne



NIEBEZPIECZEŃSTWO

Występuje potencjalne zagrożenie wskutek źle dobranych wielkości przekrojów przewodów.

Urządzenie nadaje się wyłącznie do pracy z załączonymi przewodami przyłączeniowymi (lub ich odpowiednikami).
W razie wątpliwości należy skonsultować się z producentem/dostawcą.

- Kable przyłączeniowe ułożyć bezpiecznie od zbiornika urządzenia do urządzenia sterującego (np. za pomocą rury ochronnej na kable). Zapewnić wystarczającą długość kabla do konserwacji elementów elektrycznych.
- ▶ Na zakończeniach przewodów przymocować końcówki kablowe (długość 8 mm).
- ▶ Odkręcić i zdjąć pokrywę obudowy.

Mono/Duo: 4 śruby w każdym rogu pokrywy obudowy

- ▶ Przeprowadzić kabel połączeniowy przez odpowiedni dławik kablowy i w razie potrzeby wyłamać wyznaczone punkty na potrzebnych dławikach kablowych. ❶



UWAGA

Stosować się do IP54

- ▶ Wykonać przepusty kablowe przy użyciu odpowiedniego narzędzia. ❷
- ▶ Wcisnąć gumowe przepusty kablowe w otwory. ❸
- ▶ Odciąć końcówki z włożonych przepustów kablowych. ❹
- ▶ Podłączyć kabel przyłączeniowy do listew zaciskowych zgodnie ze schematem połączeń.
W tym celu użyć odpowiedniego śrubokręta – docisnąć odpowiedni zacisk kabla do zacisku sprężynowego, aż zostanie wetknięta w niego końcówka kabla. ❺

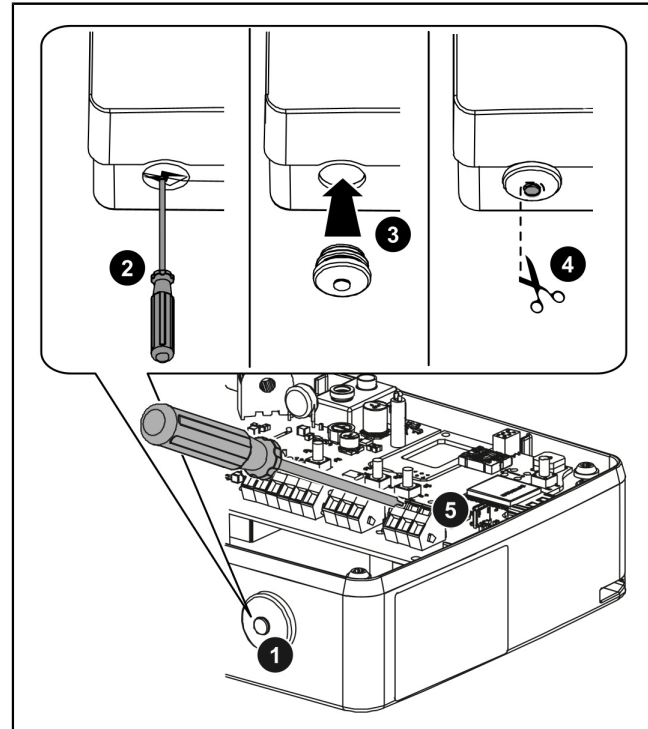

- ▶ Kable przyłączeniowe ułożyć bezpiecznie od zbiornika urządzenia do urządzenia sterującego (np. za pomocą rury ochronnej na kable). Zapewnić wystarczającą długość kabla do konserwacji elementów elektrycznych.
- ▶ Podłączyć wtyczkę baterii do baterii. **6**
- ▶ Kabel baterii należy poprowadzić w taki sposób, aby LED nie były zakryte ani zakleszczone.
- ▶ Zamocować odciążenia dla wszystkich kabli przyłączeniowych (moment dokręcający 0,5 Nm). **7**
- ▶ Nałożyć i zamocować pokrywę obudowy (moment dokręcający dla śrub 1,2 Nm).

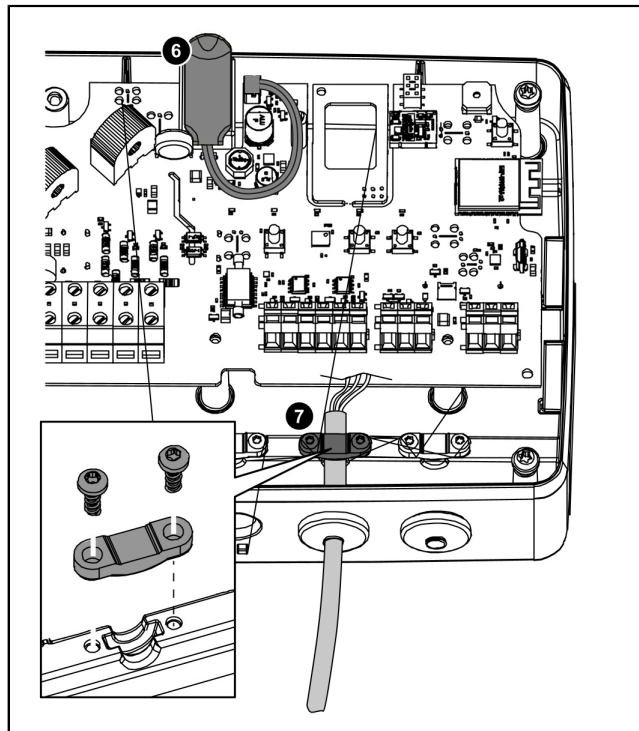

5 Eksploatacja

5.1 Tryb automatyczny

Urządzenie jest w trybie automatycznym, jeśli nie wykryto żadnego błędu, a dioda LED (1) świeci się na zielono.

Pompa ściekowa włącza i wyłącza się odpowiednio do poziomu ścieków.

W przypadku sterowników 400V Mono/Duo możliwe jest korzystanie z aplikacji KESSEL NFC i urządzenia końcowego obsługującego NFC (np. smartfonu) w celu odczytu dziennika sterownika, synchronizacji daty i godziny oraz dostosowania różnych parametrów.

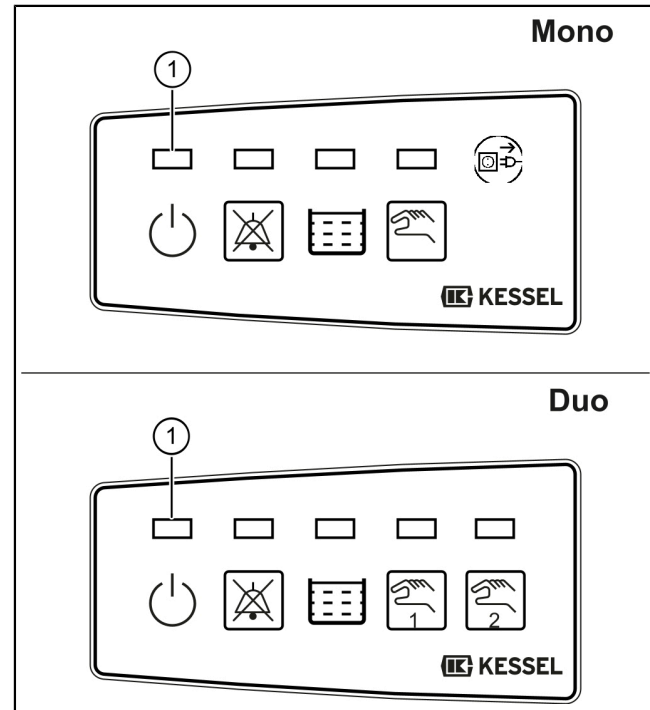

5.2 Stany alarmowe

Alarm zbiornik urządzenia przepelniony

- Jeśli poziom w zbiorniku urządzenia przekroczy poziom alarmowy (przełącznik pływakowy), zainicjowany zostanie alarm, LED alarmu (2) będzie migać i zostanie wygenerowany sygnał dźwiękowy. Pompa ściekowa pracuje.
- Tego alarmu nie da się skasować, zostaje on wyłączony tylko przez pomyślne opróżnienie zbiornika. Sygnał akustyczny można wyłączyć (krótko wcisnąć przycisk alarmu).

Alarm awaria zasilania

- W przypadku zaniku zasilania zielona LED robocza (1) zgaśnie po jednej sekundzie, a LED alarmu (2) zacznie migać i wygenerowany zostanie powtarzający się sygnał dźwiękowy. Pompa ściekowa nie może zostać włączona.
- Gdy zasilanie wróci, urządzenie sterujące nie będzie już sygnalizować tego stanu alarmowego, a urządzenie działa znów jak w trybie automatycznym.

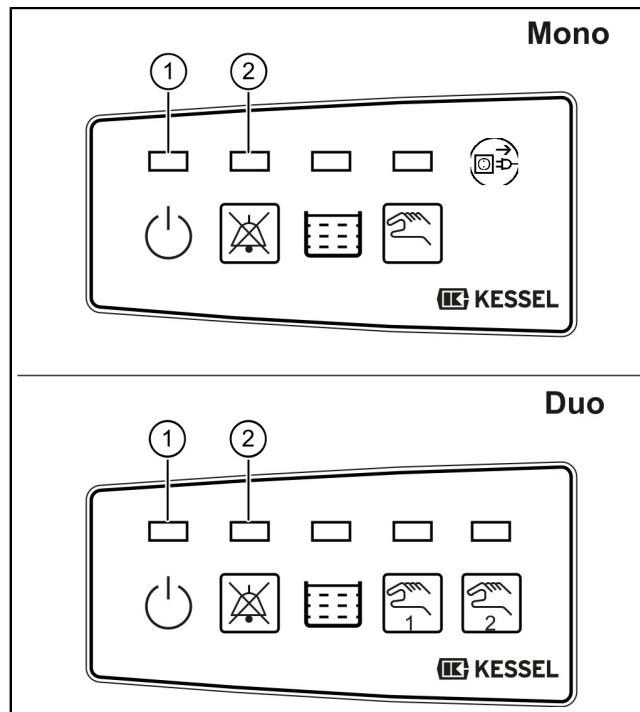

5.3 Tryb ręczny

Tryb ręczny można aktywować przyciskiem (9) / (10). W tym trybie nie następuje automatyczne włączenie pompy ściekowej.

Jeśli podczas odpompowywania zostanie włączony tryb ręczny, pompa ściekowa wyłączy się.

Aktywowanie trybu ręcznego

- ▶ Nacisnąć przycisk (9) / (10), LED trybu ręcznego (4) / (5) miga na pomarańczowo.

Gdy aktywny jest tryb ręczny, pompę ściekową można włączyć w następujący sposób:

Włączenie na chwilę

- ▶ Nacisnąć 1x przycisk (9) / (10).
- ✓ Pompa ściekowa zostanie włączona na krótką chwilę.

Włączenie na dłużej



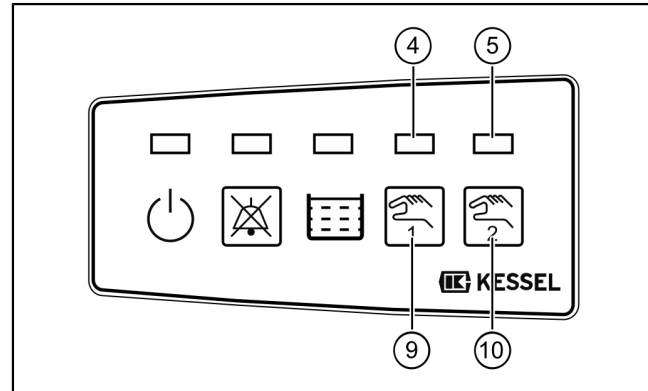

- ▶ Nacisnąć przycisk (9) / (10) i przytrzymać tak długo, jak długo ma być włączona pompa ściekowa.
- ✓ Pompa do ścieków zostanie włączona.

ⓘ Jeżeli tryb ręczny nie jest używany > 5 minut, sterownik załącza z powrotem tryb automatyczny.









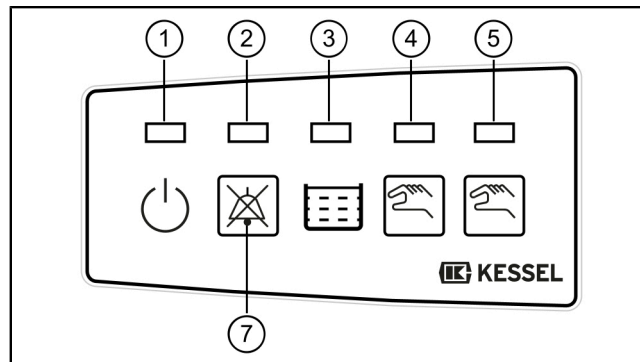













5.4 Przegląd wskaźników LED – informacje

Symbole migania LED 1 - 5*

-  Miga
-  Świeci się / włączona
-  Wyłączona
-  Migają na zmianę
-  Migają jednocześnie
- 5* Tylko dla Aqualift L DUO



Stany robocze

























Dioda LED				Sygnał dźwiękowy (przerwany)	Kontakt bezpotencjałowy ¹	Opis	Środek
 zielona (1)	 czerwona (2)	 pomarańczowa (3)	 pomarańczowa (4) / (5*)				
				-	-	Urządzenie nie działa, brak monitorowania baterii. ²	Przywrócić napięcie sieciowe.
				-	-	Gotowość do pracy	-
				-	-	Zbiornik urządzenia jest pełny, w najbliższym czasie rozpocznie się odpompowywanie.	Nie jest konieczne podjęcie jakichkolwiek działań, pompę ścieków można wyłączyć przyciskiem (8) (patrz "Tryb ręczny", strona 129)
				-	-	Zbiornik urządzenia jest opróżniany.	









¹ Kontakt bezpotencjałowy jest aktywowany (nr art. 80074, musi być wcześniej aktywowany i podłączony).

² Monitorowanie baterii jest aktywne tylko wtedy, jeśli podczas uruchomienia bateria była podłączona.

5* Tylko dla Aqualift L DUO

Stany alarmowe / błędy

Dioda LED				Sygnał dźwiękowy (przerwywany)	Kontakt bezpotencjałowy ¹	Opis	Środek
 zielona (1)	 czerwona (2)	 pomarańczowa (3)	 pomarańczowa (4)/ (5*)				
				✓	tak	Błąd baterii ²	Wymienić baterię.
				✓	tak	Awaria sieci, brak napięcia sieciowego, urządzenie nie działa.	Przywrócić napięcie sieciowe, potwierdzić alarm.
				✓	tak	Błąd poziomu, rozpoznana została nielogiczna kolejność poziomów.	Potwierdzić alarm: sprawdzić dopływ, zawór zwrotny, błędy poziomy - sprawdzić pływak.
				✓	tak	Maksymalna liczba biegów / maksymalny czas biegu, pompa do ścieków była włączana za często / za długo.	
				✓	tak	Poziom powyżej poziomu alarmowego	Zaczeekać, aż poziom spadnie ponownie poniżej poziomu alarmowego.

Dioda LED				Sygnał dźwiękowy (przerwany)	Kontakt bezpotencjałowy ¹	Opis	Środek
 zielona (1)	 czerwona (2)	 pomarańczowa (3)	 pomarańczowa (4)/ (5*)				
				-	-	Przekroczono maksymalną ilość załączeń.	Potwierdzić alarm i wymienić urządzenie sterujące.

¹ Kontakt bezpotencjałowy zostaje aktywowany.

² Monitorowanie baterii jest aktywne tylko wtedy, jeśli podczas uruchomienia bateria była podłączona.

5* Tylko dla Aqualift L DUO

Kasowanie alarmu

W przypadku wystąpienia stanu, który wyzwała alarm, sygnalizowany jest on za pomocą świecącej się diody LED alarmu (2) oraz ewentualnie jednej z pozostałych diod LED. Po wyeliminowaniu przyczyny alarmu, alarm można potwierdzić naciskając przycisk (7).

Wyłączyć sygnał alarmowy.

► Wcisnąć 1x przycisk (7).

Kasowanie alarmu

► Wcisnąć przycisk (7) i przytrzymać > 3 sekund.

✓ Wskaźnik alarmu gaśnie, alarm został potwierdzony.

5.5 Odczyt danych i nastawa parametrów

Aplikacja KESSEL NFC na urządzeniu obsługującym NFC (np. na smartfonie) umożliwia odczyt dziennika sterownika, synchronizację daty i godziny oraz ustawianie różnych parametrów.



OSTRZEŻENIE

Przed użyciem aplikacji należy uruchomić sterownik *patrz "rozdział Eksploatacja", strona 127.*

Apple Store



<https://apps.apple.com/de/app/kessel-nfc/id6449256249>

Google Play Store



<https://play.google.com/store/apps/details?id=com.kessel-nfcapp&gl=DE>

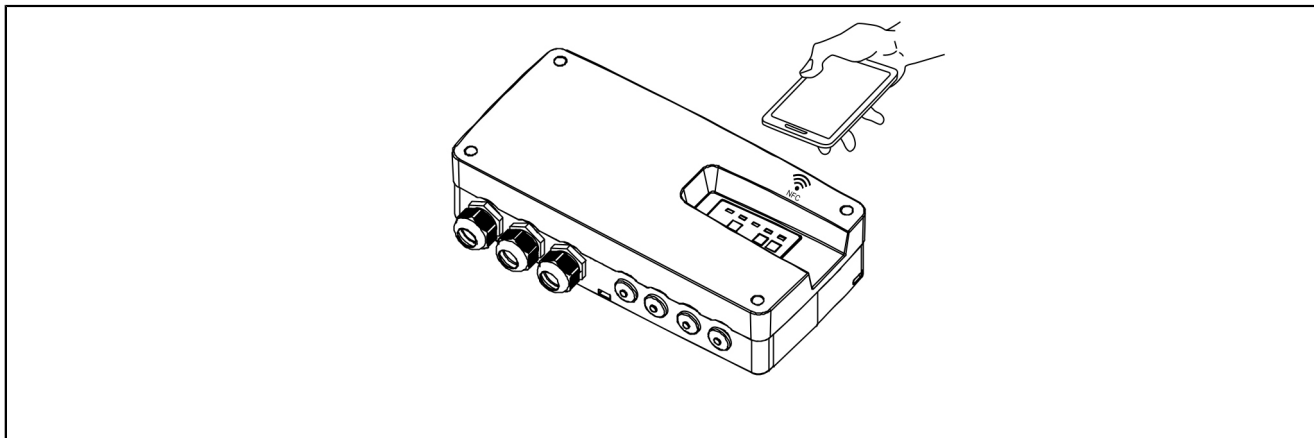

Rys.: Urządzenie końcowe - smartfon

Odczyt sterownika

W tym celu urządzenie końcowe obsługujące NFC musi znajdować się bezpośrednio przy sterowniku ("rys. *Urządzenie końcowe-smartfon*").

Odczyt i edycja parametrów:

Można je kopiować i wysyłać per e-mail. (Hasło 1000)

5.6 Synchronizacja daty/godziny

Przesyłanie wartości z urządzenia obsługującego NFC do sterownika.

5.7 Wyłączenie urządzenia

- ▶ Odłączyć urządzenie od prądu.
 - ▶ Wcisnąć przycisk alarmu (7) i przytrzymać go, aż LED alarmu (2) przestanie migać, urządzenie sterujące wyłącza się wtedy samoczynnie.
- ① Gdy urządzenie sterujące jest wyłączone, przyłączy baterii jest dezaktywowane. Bateria może pozostać włożona, nie jest ona rozładowywana. Do inicjalizacji potrzebne jest napięcie sieciowe, aby przyłączy baterii mogło zostać ponownie aktywowane.

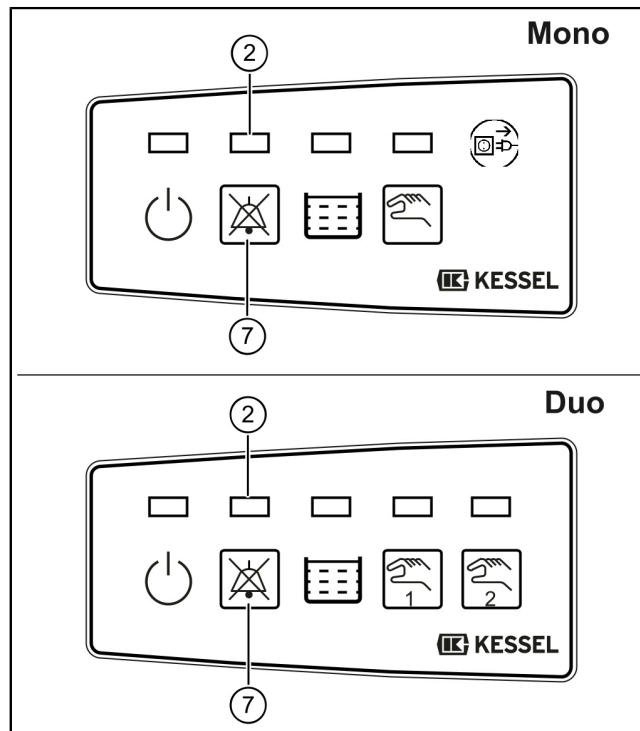

Anschlussplan Mono 400V - Wiring Diagram Mono 400V: Aquapump Small und Aqualift L

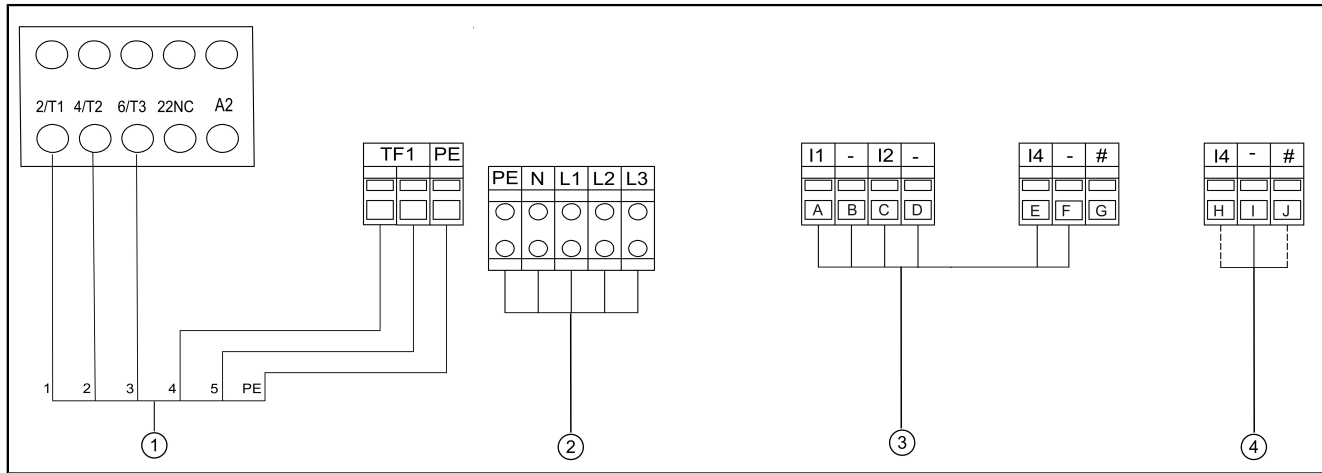

	DE	EN	FR	IT	NL	PL
1	Abwasserpumpe	Wastewater pump	Pompe démarre	Pompa delle acque di scarico	Afvalwaterpomp	Pompą do ścieków
2	Netzanschluss	Voltage	Raccordement au réseau	Voltaggio	Netaansluiting	Podłączenie do sieci
3	Schwimmerschalter	Float switch	Interrupteur à flotteur	Interruttore a galleggiante	Vlotterschakelaar	Przełącznik pływakowy
A	Gelb	Yellow	Ambrée	Giallo	Geel	Żółty
B	Weiß	White	Blanc	Bianco	Wit	Biały
C	Rosa	Rose	Rose	Rosa	Roze	Różowy
D	Braun	Brown	Marron	Marrone	Bruin	Brązowy
E	Grau	Grey	Gris	Grigio	Grijs	Szary
F	Grün	Green	Vert	Verde	Groen	Zielony
G	Nicht belegt	Not used	Non affecté	Non assegnato	Niet toegewezen	Nieprzypisany
4	Potentialfreier Kontakt	Potentialfree contact	Contact sec	Contacto a potenziale zero	Potentialvrij contact	Kontakt bezpotencjalowy
H				NC		
I				COM		
J				NO		

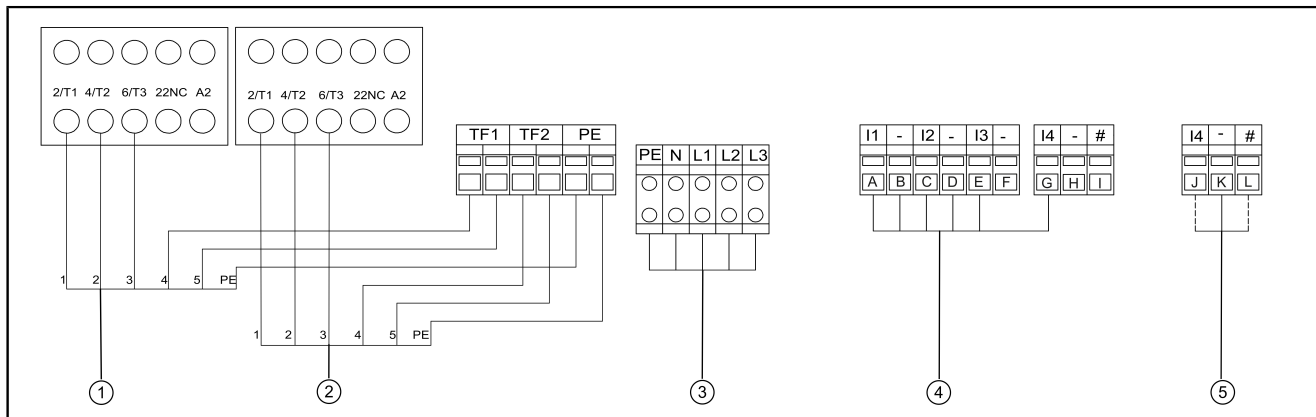
Anschlussplan Duo 400V - Wiring Diagram Duo 400V: Aquapump Small Duo

	DE	EN	FR	IT	NL	PL
1, 2	Abwasserpumpe	Wastewater pump	Pompe démarre	Pompa delle acque di scarico	Afvalwaterpomp	Pompą do ścieków
3	Netzanschluss	Voltage	Raccordement au réseau	Voltaggio	Netaansluiting	Podłączenie do sieci
4	Schwimmerschalter	Float switch	Interrupteur à flotteur	Interruttore a galleggiante	Vloterschakelaar	Przełącznik pływakowy
A	Gelb	Yellow	Ambrée	Giallo	Geel	Żółty
B	Weiß	White	Blanc	Bianco	Wit	Biały
C	Rosa	Rose	Rose	Rosa	Roze	Różowy
D	Braun	Brown	Marron	Marrone	Bruin	Brązowy
E	Grau	Grey	Gris	Grigio	Grijs	Szary
F	Nicht belegt	Not used	Non affecté	Non assegnato	Niet toegewezen	Nieprzypisany
G	Grün	Green	Vert	Verde	Groen	Zielony
H, I	Nicht belegt	Not used	Non affecté	Non assegnato	Niet toegewezen	Nieprzypisany
5	Potentialfreier Kontakt	Potentialfree contact	Contact sec	Contatto a potenziale zero	Potentialvrij contact	Kontakt bezpotencjałowy
J				NC		
K				COM		
L				NO		

Anschlussplan Duo 400V - Wiring Diagram Duo 400V: Aqualift L Duo

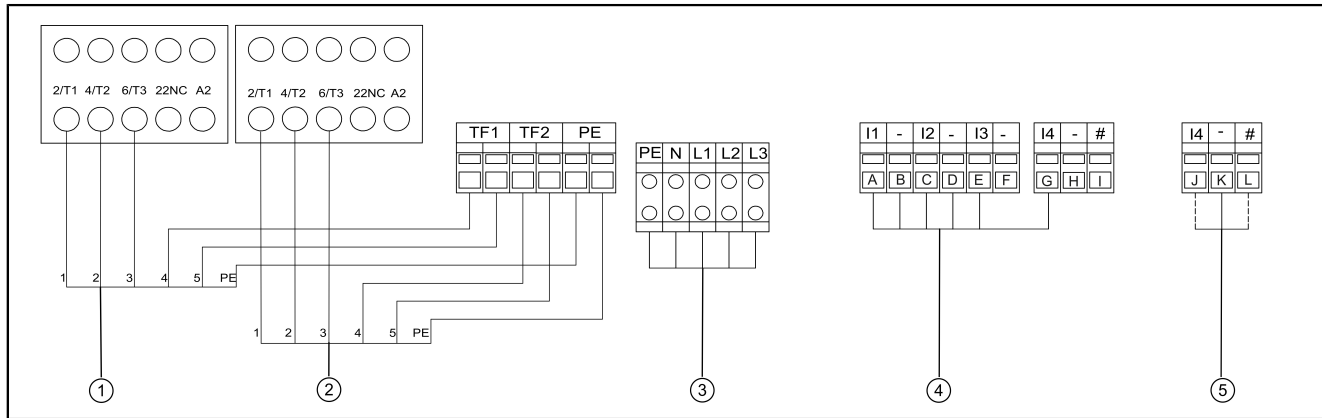

	DE	EN	FR	IT	NL	PL
1, 2	Abwasserpumpe	Wastewater pump	Pompe démarre	Pompa delle acque di scarico	Afvalwaterpomp	Pompą do ścieków
3	Netzanschluss	Voltage	Raccordement au réseau	Voltaggio	Netaansluiting	Podłączenie do sieci
4	Schwimmerschalter	Float switch	Interrupteur à flotteur	Interruttore a galleggiante	Vlotterschakelaar	Przełącznik pływakowy
A	Gelb	Yellow	Ambrée	Giallo	Geel	Żółty
B	Weiß	White	Blanc	Bianco	Wit	Biały
C	Rosa	Rose	Marron	Rosa	Roze	Różowy
D	Braun	Brown	Marron	Marrone	Bruin	Brązowy
E	Grün	Green	Vert	Verde	Groen	Zielony
F	Nicht belegt	Not used	Non affecté	Non assegnato	Niet toegewezen	Nieprzypisany
G	Grau	Grey	Gris	Grigio	Grijs	Szary
H, I	Nicht belegt	Not used	Non affecté	Non assegnato	Niet toegewezen	Nieprzypisany
5	Potentialfreier Kontakt	Potentialfree contact	Contact sec	Contacto a potenziale zero	Potentialvrij contact	Kontakt bezpotencjałowy
J				NC		
K				COM		
L				NO		

Dokumentnummer / doc. number	Original Doc 009-590-03
Hersteller / manufacturer	KESSEL SE + Co. KG, Bahnhofstraße 31, D-85101 Lenting
Produktbezeichnung / product name	KESSEL Schaltgerät Connect 400 V KESSEL control unit Connect 400 V
Kennzeichen zur Identifikation / Identification code	gemäß Kennzeichnung according to the relevant marking

Berücksichtigte Richtlinie/n / directive/s considered:

2014/53/EU	Funkanlagen-Richtlinie, welche auch die Anforderungen der Richtlinie für Elektromagnetische Verträglichkeit 2014/30/EU abdeckt / Radio Equipment Directive RED, which also covers the requirements of Directive on electromagnetic compatibility (EMC) 2014/30/EU
2014/35/EU	Niederspannungsrichtlinie / Low Voltage Directive (LVD)
2011/65/EU	Richtlinie zur Beschränkung der Verwendung bestimmter gefährlicher Stoffe in Elektro- und Elektronikgeräten (RZGS) / Directive on the restriction of the use of certain hazardous substances in electrical and electronic equipment (RoHS)

Zugrunde gelegte Normen / Relevant standards:

EN IEC 61000-6-2: 2019	Elektromagnetische Verträglichkeit (EMV) - Teil 6-2: Fachgrundnormen - Störfestigkeit für Industriebereiche / Electromagnetic compatibility (EMC) - Part 6-2: Generic standards - Immunity standard for industrial environments
EN IEC 61000-6-3: 2021	Elektromagnetische Verträglichkeit (EMV) - Teil 6-3: Fachgrundnormen - Störausendung von Geräten in Wohnbereichen / Electromagnetic compatibility (EMC) - Part 6-3: Generic standards - Emission standard for equipment in residential environments
EN 60204-1: 2018	Sicherheit von Maschinen - Elektrische Ausrüstung von Maschinen - Teil 1: Allgemeine Anforderungen / Safety of machinery - Electrical equipment of machines - Part 1: General requirements
EN IEC 63000: 2018	Technische Dokumentation zur Beurteilung von Elektro- und Elektronikgeräten hinsichtlich der Beschränkung gefährlicher Stoffe / Technical documentation for the assessment of electrical and electronic products with respect to the restriction of hazardous substances

Wir als Hersteller erklären in alleiniger Verantwortung die Übereinstimmung der obengenannten Produkte mit den angeführten Harmonisierungsvorschriften der EU. Die aufgeführten einschlägigen harmonisierten Normen der EU wurden für die Konformität zugrunde gelegt. / As manufacturer we declare under the sole responsibility that the above listed products are in conformity with the relevant harmonisation legislation of the European Community as listed. The listed relevant harmonised standards are used to declare the conformity.

Herr Priller Roland ist bevollmächtigt, dieses Dokument zu repräsentieren in der /
Mister Priller Roland is authorized to represent this technical file within
KESSEL SE + Co. KG, Bahnhofstraße 31, D-85101 Lenting, +49 84 56 270, roland.priller@kessel.de

Unterzeichnet für und im Namen der KESSEL SE + Co. KG/ Signed and on behalf of KESSEL SE + Co. KG
Lenting – Deutschland / Germany, 2024-08-13



Edgar Thiemert
Vorstand Technik / Managing Board



i.V. Roland Priller
Dokumentenverantwortlicher / Responsible for Doc.

Dokumentnummer / doc. number	UK-DoC-009-590-03
Hersteller / manufacturer	KESSEL SE + Co. KG, Bahnhofstraße 31, D-85101 Lenting
Produktbezeichnung / product name	KESSEL Schaltgerät Connect 400 V KESSEL control unit Connect 400 V
Kennzeichen zur Identifikation / Identification code	gemäß Kennzeichnung according to the relevant marking

Berücksichtigte Richtlinien / directives considered:

2014/30/EU	Elektromagnetische Verträglichkeit / Electromagnetic compatibility regulations 2016
2014/35/EU	Niederspannungsrichtlinie / Electrical Equipment (Safety) Regulations 2016
2011/65/EU	Richtlinie zur Beschränkung der Verwendung bestimmter gefährlicher Stoffe in Elektro- und Elektronikgeräten / Directive on the restriction of the use of certain hazardous substances in electrical and electronic equipment

Zugrunde gelegte Normen / Relevant standards:

EN IEC 61000-6-2: 2019	Elektromagnetische Verträglichkeit (EMV) - Teil 6-2: Störfestigkeit für Industriebereiche / Electromagnetic compatibility (EMC) - Part 6-2: Generic standards - Immunity standard for industrial environments
EN IEC 61000-6-3: 2021	Elektromagnetische Verträglichkeit (EMV)- Teil 6-3: Störaussendung für Wohnbereichen / Electromagnetic compatibility (EMC) - Part 6-3: Emission standard for equipment in residential environments
EN 60204-1: 2018	Sicherheit von Maschinen - Elektrische Ausrüstung von Maschinen- Teil 1: Allgemeine Anforderungen / Safety of machinery – Electrical equipment of machines – part 1 – General requirements
EN IEC 63000: 2018	Technische Dokumentation zur Beurteilung von Elektro- und Elektronikgeräten hinsichtlich der Beschränkung gefährlicher Stoffe / Technical documentation for the assessment of electrical and electronic products with respect to the restriction of hazardous substances

Wir als Hersteller erklären die Übereinstimmung der obengenannten Produkte mit den angeführten Harmonisierungsvorschriften. Die aufgeführten einschlägigen harmonisierten Normen und ggf. weiterer Spezifikationen wurden für die Konformität zugrunde gelegt. Im Falle von Änderungen an den Produkten, die nicht durch die KESSEL freigegeben wurden, verliert diese Konformitätserklärung ihre Gültigkeit. /
As manufacturer we declare that the above listed products are in conformity with the relevant harmonisation legislation as listed. The listed relevant harmonised standards and other related specifications are used to declare the conformity. If any modifications which have not been approved by KESSEL are made to the products, this Declaration of Conformity is no longer valid.

Lenting, 2024-08-13



Edgar Thiemt
Vorstand Technik / Managing Board



i.V. Roland Priller
Dokumentenverantwortlicher / Responsible for Doc.



016-306



Registrieren Sie Ihr Produkt online, um von einer schnelleren Hilfe zu profitieren.

<http://www.kessel.de/service/produktregistrierung>

KESSEL SE + Co. KG, Bahnhofstr. 31, 85101 Lenting, Deutschland

